

1657 RLC Digibridge®

Instruction Manual

Form 1657-0120-07/B1

©QuadTech, Inc., 1992
5 Clock Tower Place, 210 East
Maynard, Massachusetts, U.S.A. 01754
January, 1997

Tel. 978-461-2100
800-253-1230 (Sales)
800-253-1230 (Service)
Fax. 978-461-4295

The material in this manual is for informational purposes only and is subject to change, without notice. QuadTech assumes no responsibility for any error or for consequential damages that may result from the misinterpretation of any procedures in this publication.

Contents

Instruction Manual Changes
Specifications
Warranty
Introduction -Section 1
Installation -Section 2
Operation -Section 3
Theory -Section 4
Service and Maintenance -Section 5
Parts Lists and Diagrams -Section 6



Product will be marked with this symbol (ISO#3684) when it is necessary for the user to refer to the instruction manual in order to prevent injury or equipment damage.

Instruction Manual Changes

These two supplementary pages contain information of improvements or modifications not documented in the current manual. All references to GenRad in the manual now apply to QuadTech, Inc.

Page -Specifications (Power & Mechanical)

Power should be 90 -250V AC, 50 -60 Hz. Voltage switching is automatic and no longer selected by rear panel switch. 60 Watts maximum.

Weight should be 10 lbs. (4.5 kg) net, 15 lbs. (6.8 kg) shipping.

Environment reads, Altitude < 2000m, Installation Category 1, Pollution Degree 1

Page - Table of Contents (Parts List and Diagrams -Section 6)

Power supply board (1657-4720) layout and diagram (page 6-13) replaced by Power supply assembly part number 700011 (no diagrams, repair by module exchange)

Page 1-4 -Figure 1-2, Rear Panel Controls and Connectors

Rear view should show new power supply assembly (PN 700011) without line-voltage switch.

Page 1-4 -Table 1-2, Rear Panel Connectors and Controls

Ref No. 2R -&  Fuse is 6/10A, 250V, 3AG Type, Slow Blow. Replace only with the same type and rating. To replace, remove fuse drawer by pressing up on release tab.

Ref No. 3R -Line-voltage switch has been deleted, power input is from 90 -250V AC

Page 1-4 -Table 1-3, Accessories

A quantity of two spare fuses are supplied, 6/10A, 250V, 3AG Type, Slow Blow (QuadTech part number 5330-1100)

Page 2-1 -Safety Inspection

Before operating the instrument inspect the power inlet module on the rear of the unit to

 ensure that the **properly rated fuse is in place**, otherwise damage to unit is possible. Fuse is 6/10A, 250V, 3AG Type, Slow Blow.

The 1657 is shipped with a standard U.S. power cord, QuadTech PN 4200-0300 (with Belden SPH-386 socket or equivalent, and 3 wire plug conforming to IEC 320) or an approved international cord set. Make sure the instrument is only used with these or other approved international cord sets, which ensures the instrument is provided with connection to protective earth ground.

In all installations the instrument should be positioned with consideration for ample air flow to the side and rear panel ventilation holes. An open space around the instrument of at least 3 inches (75mm) is recommend. The surrounding environment should be free from excessive dust to prevent contamination of electronic circuits.

Instruction Manual Changes (continued)

WARNING

If this instrument is used in a manner not specified in this manual protection to the operator and equipment may be impaired.

Page 2-1 -Power-Line Connection

Power line switch for 115V or 230V operation has been removed, switching is automatic for voltages between 90 -250V AC.

Page 2-2 -Figure 2-2

Figure 2-2 does not apply. Only certified line cords which comply with IEC 227 or IEC 245 should be used.

Page 3-2 -Paragraph 3.1 Basic Procedure, step a

Power line switch for 115V or 230V operation has been removed, switching is automatic.

Page 5-1 -Paragraph 5.2, Instrument Return

Contacts for QuadTech are:	Sales	800-253-1230
	Service	800-253-1230
	Technical Assistance	978-461-2100

Page 5-2 & Page 5-3 -Caution Note

Power line switch for 115V or 230V operation has been removed, switching is automatic.



Page 5-7 -& Paragraph 5.6.1 & Figure 5-3, Disassembly

Power Supply Assembly shown has been replaced by Power Supply Assembly PN 700011.

Page 5-10 -Instrument Cleaning Instructions

Monthly (more or less depending on usage) the built-in test fixture should be cleaned with a soft brush and isopropyl alcohol. Avoid getting excess alcohol on instrument paint surfaces, otherwise damage to the finish can result. For additional instrument cleaning instructions refer to paragraph 5.7.1 (Care of the Test Fixture) and paragraph 5.7.2 (Care of the Display Panel).

Power Supply Assembly shown in Figure 5-8 has been replaced by Power Supply Assembly PN 700011.

Page 5-12 - Paragraph 5.8.2, Power Supply

Trouble Analysis procedure does not apply to new Power Supply Assembly P/N 700011.

Page 6-2 - Figure 6-2, Rear View

Rear view should show new power supply (PN 700011) without line-voltage switch

Page 6-3 - Mechanical Parts List, Rear

Items 1 - 4 (power connector, fuse extractor post, line voltage switch & cover) deleted on new assembly

Page 6-12 & Page 6-13 - Parts and Diagrams

Power Supply Board and Parts List shown, PN 1657-4720 has been replaced by Power Supply Assembly, PN 700011. The 700011 Assembly must be repaired by module exchange.

Specifications

Measurement Mode: Measures R series or parallel; L and Q series or parallel; C and D series or parallel. All measurement modes are pushbutton selectable.

Displays: LED-type numerical display with automatically positioned decimal points and illumination of units. For R LC, five digits (99999) and simultaneously for DQ, four digits (9999).

Measurement Speed: Greater than 3 measurements per second.

Test frequencies: Pushbutton selection between 2. Accuracy re panel legends: +2%, -.01%. Actual frequencies: for 1657-9700, 1020.0 Hz +/- .01% (panel legend "1 kHz") and 120.00 Hz +/- .01%; for 1657.9800, 1000.0 and 100.00 Hz +/- .01%.

Applied Voltage: 0.3 V rms maximum.

Ranges: Pushbutton selection with automatic front-panel guidance. Three basic ranges (best accuracy, see table) of 2 decades each, for each parameter. Automatic extensions to min and max, as tabulated.

Parameter	Minimum	Basic ranges	Maximum
R; 120 Hz*	00.001 Ω	2 Ω to 2 MΩ	99.999 MΩ
R; 1 kHz	00.001 Ω	2 Ω to 2 MΩ	9.9999 MΩ
L; 1 kHz	0.0001 mH	0.2 mH to 200 H	999.99 H
L; 120 Hz*	00.001 mH	2 mH to 2000 H	9999.9 H
C; 1 kHz	0.0001 nF	0.2 nF to 200 μF	999.99 μF
C; 120 Hz*	00.001 nF	2 nF to 2000 μF	99999 μF
D (with C)	.0001	(fully automatic)	9.999
Q (with L)	00.01	(fully automatic)	999.9

*120 Hz or 100 Hz, depending on the instrument.

Accuracy: For R, L, and C: +/- 0.2% of reading in basic ranges, if quadrature component is small (D < 0.1, Q > 10, etc). See table. D accuracy: +/- .001 in basic ranges, for D < 0.1 (otherwise, see table). Q accuracy: +/- .01 in basic ranges, for Q < 1 (otherwise, see table).

Parameter	Basic accuracy			Cross-term factor
	Low extension	Basic ranges	High extension	
R; either frequency	±[4 mΩ,	0.2% of rdg,	(R/10 MΩ)% of rdg] (1 + Q)
L; 1 kHz	±[0.4 μH,	0.2% of rdg,	(L/1000 H)% of rdg	
L; 120 Hz*	±[4 μH,	0.2% of rdg,	(L/10 kHz)% of rdg] (1 + 1/Q)
C; 1 kHz	±[0.4 pF**,	0.2% of rdg,	(C/1000 μF)% of rdg	
C; 120 Hz*	±[4 pF**,	0.2% of rdg,	(C/.01 F)% of rdg] (1 + D)
D (with C)	±[.001 + 0.2 (1 + D)% of rdg		
Q (with L)	±[.01 + 0.2 (1 + Q)% of rdg] K [†]

*120 Hz or 100 Hz. **Fixed offset "zero" capacitance is < 1.5 pF.

†K = (LC basic accuracy as % of rdg) / 0.2%. Therefore, K = 1 on basic ranges.

Environment: TEMPERATURE: 0° to 50°C operating, -40° to +75°C storage. HUMIDITY: 0 to 85% R.H., operating.

Supplied: Power cord, axial-lead adaptors, instruction manual.

Power: 90 to 125 or 180 to 250 V, 50 to 60 Hz. Voltage selected by rear-panel switch. 25 W maximum.

Mechanical: Bench mounting. DIMENSIONS: (wxhxd): 375x112x343 mm (14.8x4.4x13.5 in.). WEIGHT: 5.6 kg (12.3 lb) net, 10 kg (22 lb) shipping.

Description	Catalog Number
1657 RLC Digibridge®	
120-Hz and 1-kHz Test Frequencies	1657-9700
100-Hz and 1-kHz Test Frequencies	1657-9800

Accessories

Extender Cable with banana plugs/alligator clips	1657-9600
Extender Cable with type 874 coaxial connectors	1688-9600
Remote Test Fixture (requires BNC adaptor)	1689-9600
BNC Adaptor	1689-9601
BNC Cable Assembly (for 1689-9600, 1689-9601)	1689-9602

Warranty



QuadTech warrants that Products are free from defects in material and workmanship and, when properly used, will perform in accordance with QuadTech's applicable published specifications. If within one (1) year after original shipment it is found not to meet this standard, it will be repaired, or at the option of QuadTech, replaced at no charge when returned to a QuadTech service facility.

Changes in the Product not approved by QuadTech shall void this warranty.

QuadTech shall not be liable for any indirect, special or consequential damages, even if notice has been given of the possibility of such damages.

This warranty is in lieu of all other warranties, expressed or implied, including, but not limited to any implied warranty or merchantability or fitness for a particular purpose.

SERVICE POLICY

QuadTech policy is to maintain product repair capability for a period of five (5) years after original shipment and to make this capability available at the then prevailing schedule of charges.

Table of Contents

Specifications			
Warranty			
Introduction -- Section 1			
1.1 Purpose	1-1		
1.2 General Description	1-1		
1.3 Controls, Indicators, and Connectors	1-1		
1.4 Accessories	1-1		
Installation -- Section 2			
2.1 Unpacking and Inspection	2-1		
2.2 Dimensions	2-1		
2.3 Power-Line Connection	2-1		
2.4 Line-Voltage Regulation	2-2		
2.5 Test-Fixture Connections	2-2		
2.6 External Bias	2-3		
2.7 Environment	2-4		
Operation -- Section 3			
3.1 Basic Procedure	3-2		
3.2 Connection of the DUT	3-3		
3.2.1 The Integral Test Fixture	3-3		
3.2.2 The Extender Cable	3-3		
3.3 Function and Range Selections	3-3		
3.3.1 Function Pushbuttons	3-3		
3.3.2 Range Pushbuttons	3-3		
3.4 Accuracy	3-4		
3.4.1 Graphs	3-4		
3.4.2 Insignificant Digits	3-6		
3.5 Parallel/Series and Frequency Selections	3-6		
3.5.1 General	3-6		
3.5.2 Rules	3-6		
3.5.3 Series and Parallel Parameters	3-6		
3.5.4 Equivalent Series R for Capacitors	3-7		
3.5.5 Parallel Equivalent Circuits for Inductors	3-7		
3.6 Bias	3-7		
3.7 Correction for Cable	3-8		
Theory -- Section 4			
4.1 Introduction	4-1		
4.1.1 General	4-1		
4.1.2 Brief Description of the 1657 Digibridge	4-1		
4.1.3 Block Diagram	4-1		
4.2 Principal Functions	4-2		
4.2.1 Elementary Measurement Circuit	4-2		
4.2.2 Frequency and Time Source	4-3		
4.2.3 Sine-Wave Generation	4-3		
Service and Maintenance -- Section 5			
5.1 Customer Service	5-1		
5.2 Instrument Return	5-1		
5.2.1 Returned Material Number	5-1		
5.2.2 Packaging	5-1		
5.3 Repair and Replacement of Circuit Boards	5-1		
5.4 Performance Verification	5-2		
5.5 Minimum Performance Standards	5-3		
5.5.1 General	5-3		
5.5.2 Resistance Measurement Accuracy	5-5		
5.5.3 Capacitance Measurement Accuracy	5-5		
5.5.4 D Measurement Accuracy	5-5		
5.5.5 Inductance Measurement Accuracy	5-6		
5.6 Disassembly and Access	5-6		
5.6.1 Disassembly	5-7		
5.6.2 Access	5-9		
5.6.3 Reference Designations	5-10		
5.6.4 Removal of Multiple-Pin Packages	5-10		
5.7 Periodic Maintenance	5-10		
5.7.1 Care of the Test Fixture	5-10		
5.7.2 Care of the Display Panel	5-10		
5.8 Trouble Analysis	5-11		
5.8.1 General	5-11		
5.8.2 Power Supply	5-12		
5.8.3 Sinewave Generator	5-12		
5.8.4 Front End Amplifiers and Switches	5-14		
5.8.5 Control Signal Checks	5-15		
5.8.6 Digital Circuitry	5-18		
Parts List and Diagrams -- Section 6			
6.1 General	6-1		
6.2 Reference Designations	6-1		
6.3 Diagrams	6-1		
Figure 6-1. Front view, Mechanical Parts	6-2		
Figure 6-2. Rear view, Mechanical Parts	6-2		
Federal Manufacturers Code	6-4		
Figures 6-3 ... 6-6. Analog and Control Board, 1657-4700, as follows:			
Figure 6-3. Front End Diagram	6-5		
Figure 6-4. Layout	6-6		
Figure 6-5. Signal Sources Diagram	6-7		
Figure 6-6. Digital Control Diagram	6-9		
Figure 6-7. Display (D) Board, 1658-4715, Layout	6-10		
Figure 6-8. Display (D) Board, 1658-4715, Diagram	6-11		
Figure 6-9. Power Supply (V) Board, 1657-4720			
Layout	6-13		
Figure 6-10. Power Supply (V) Assembly, 1657-4720, Diagram	6-13		

Introduction – Section 1

1.1 PURPOSE	1-1
1.2 GENERAL DESCRIPTION	1-1
1.3 CONTROLS, INDICATORS, AND CONNECTORS	1-1
1.4 ACCESSORIES	1-1

1.1 PURPOSE.

The 1657 Digibridge digital impedance meter embodies use of a microprocessor and other LSI circuitry to provide excellent performance at low cost.

A few clearly labeled pushbuttons and the versatile built-in test fixture make this instrument a model for convenience. Measurement results are clearly shown with decimal points and units, which are automatically presented to assure correctness. Display resolution is 5 digits for R, C, and L (4 for D or Q) and the basic accuracy is 0.2%.

Long-term accuracy and reliability are assured by the measurement system. It makes these accurate analog measurements over many decades of impedance without a single calibration or "trimming" adjustment (not even in original manufacture).

The built-in test fixture, with a pair of plug-in adaptors, receives any common component part (axial-lead or radial-lead) so easily that insertion of the DUT is a one-hand operation. True 4-terminal connections are made automatically. Extender cables and other accessories are available for measurements at a distance from the Digibridge.

1.2 GENERAL DESCRIPTION.

Convenience is enhanced by the arrangement of test fixture on the front ledge, with push buttons farther forward and display behind. The display panel is inclined and recessed to enhance visibility of digital readouts and mode indicators. These indicators serve to inform and guide the operator as he operates the simple controls.

The instrument stands on a table or bench top. The sturdy metal cabinet is attractively and durably finished,

in keeping with the long-life circuitry inside. Glass-epoxy circuit boards interconnect and support high-quality components to assure years of dependability.

Adaptability to any common ac power line is assured by the removable power cord and the convenient line-voltage switch. Safety is enhanced by the fused, isolating power transformer and the 3-wire power connection. A comprehensive functional description is given in Theory, Section 4. Electrical and physical characteristics are listed in Specifications at the front of this manual, dimensions in Installation, Section 2. Controls are described below, and their use in Operation, Section 3.

1.3 CONTROLS, INDICATORS, AND CONNECTORS.

Figure 1-1 shows the front panel controls and indicators. Table 1-1 identifies them with descriptions and functions.

Similarly, Figure 1-2 shows the rear panel and Table 1-2 identifies

and describes the rear panel controls and connectors.

1.4 ACCESSORIES.

Gen Rad makes several accessories that enhance the usefulness of this instrument. Two extender cables facilitate making connections to those devices and impedance standards that do not readily fit the built-in test fixture. A remote test fixture (used with BNC adaptor and cable assembly) provides convenience and relatively easy maintenance, and saves wear on the built-in test fixture. All of these test-fixture accessories provide for true 4-terminal connections (and guard) to the device being measured, without appreciable reduction in measurement accuracy. Other useful accessories are offered, such as standards for checking the performance of the Digibridge. Refer to Table 1-3 and Section 5.

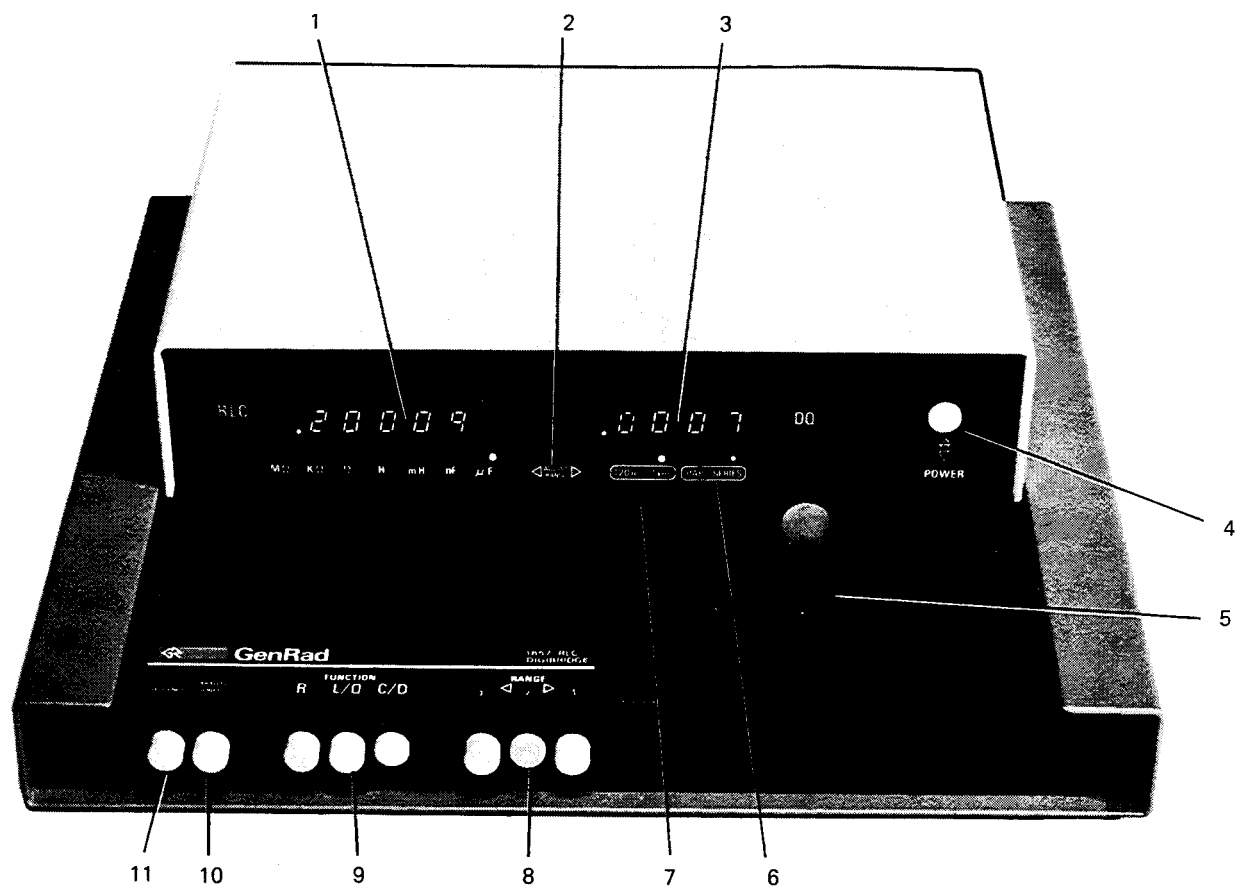

Figure 1-1. Front panel controls and displays.

Table 1-1
FRONT PANEL CONTROLS AND INDICATORS

Figure 1-1 Ref.No.	Name	Description	Function
1	RLC display	Digital display, 5 numerals with decimal points. Unit labels M Ω , k Ω , Ω , mH, nF, μ F, with 7 lights.	Display of principal measured value. Light spot indicates units.
2	ADJUST RANGE lights	Arrowheads with a light behind each.	Guides operator to optimum range. Left arrow means "try next pushbutton to left." Right arrow means the converse. No light means "Correct range." Also see para 3.3.
3	DQ display	Digital display, 4 numerals with decimal points.	Display of secondary measured value, D if you select C/D, Q if you select L/Q with item 9.
4	POWER switch	Pushbutton (push again to release).	Turns instrument ON when in, OFF when out. OFF position breaks both sides of power circuit.
5	Test fixture	Pair of special connectors; each makes dual contact with inserted wire lead of DUT.	Receives radial-lead part, making 4-terminal connection automatically. Adaptors are supplied to make similar connection with axial-lead part.
6	PARALLEL/SERIES lights	Legend with 2 lights.	Indicates the selection of parallel or series equivalent circuit of the DUT (by item 10). Refer to para 3.5.
7	Frequency lights	Legend with 2 lights, 120 Hz, 1 kHz, (or 100 Hz, 1 kHz).	Indicates the selection of test frequency by item 11.
8	RANGE pushbuttons	Set of 3 interlocked, latching pushbuttons, labeled 3, 2, 1. The latched button is released by depressing another one.	Manual selection of measurement range, in conjunction with item 9.
9	FUNCTION push-buttons	Set of 3 pushbuttons, similar to item 8, labeled R, L/Q, C/D.	Manual selection of parameter to be measured: resistance, inductance, or capacitance.
10	PARALLEL/SERIES pushbutton	Pushbutton (push again to release).	Manual selection of equivalent circuit. Item 6 indicates the one in use.*
11	FREQUENCY push-button	Pushbutton, like item 10.	Manual selection of frequency. Item 7 indicates the frequency in use.*

*When these buttons are "in", the selections are PARALLEL and 120 Hz (100 Hz).

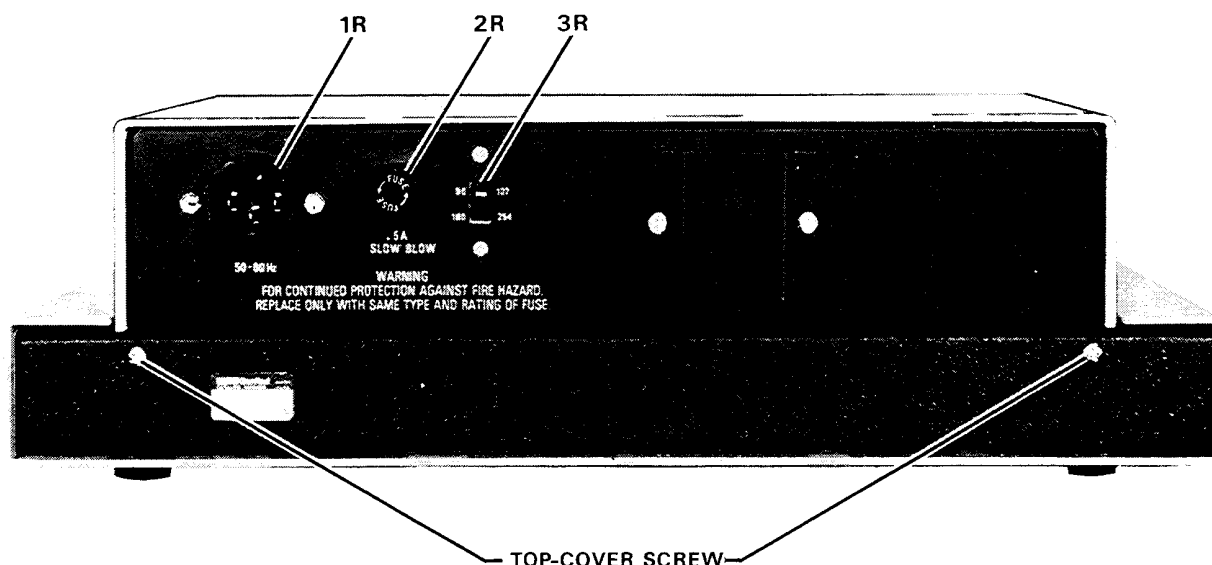

Figure 1-2. Rear panel controls and connectors.

Table 1-2
REAR PANEL CONNECTORS AND CONTROLS

Figure 1-2 Ref. No.	Name	Description	Function
1R	Power connector, (labeled 50-60 Hz)	Safety shrouded 3-wire plug, conforming to International Electrotechnical Commission 320.	Ac power input. Use appropriate power cord, such as GR 4200-9625, with Belden SPH-386 socket or equivalent.
2R	Fuse (labeled 0.5 A, 250 V, SLOW BLOW)	Fuse in extraction post holder.	Short circuit protection. Use Bussman type MDL or equivalent fuse, 1/2 A, 250 V rating.
3R	Line-voltage switch	Slide switch. Vertical motion: upper position, 90 to 125 V; lower position, 180 to 250 V	Adapts power supply to line-voltage ranges, as indicated. To operate, use small screwdriver, not any sharp object.

Table 1-3
ACCESSORIES

Quantity	Description	Part Number
1 supplied	Power cord, 210 cm (7 ft) long, 3-wire, AWG No. 18, with molded connector bodies. One end, with Belden SPH-386 socket, fits instrument. Other end is stackable (hammerhead) conforming to ANSI standard C73.11-1966 (for 125 V).	4200-9625
2 supplied	Test-fixture adaptors, for axial-lead parts	
	Reorder number, for a set of four:	1657-5996
1 available	Rack mount kit (slides forward for complete access).	1657-9000
1 available	Extender Cable with banana plugs/alligator clips. Length 100 cm (40 in.)	1657-9600
1 available	Extender Cable with type 874 coaxial connectors. Length 30 cm (12 in.)	1688-9600
1 available	Remote Test Fixture (requires BNC adaptor)	1689-9600
1 available	BNC Adaptor	1689-9601
1 available	BNC Cable Assembly (for 1689-9600, 1689-9601). Length 90 cm (36 in.)	1689-9602

Installation – Section 2

2.1 UNPACKING AND INSPECTION	2-1
2.2 DIMENSIONS	2-1
2.3 POWER-LINE CONNECTION	2-1
2.4 LINE-VOLTAGE REGULATION	2-2
2.5 TEST-FIXTURE CONNECTIONS	2-2
2.6 EXTERNAL BIAS	2-2
2.7 ENVIRONMENT	2-3

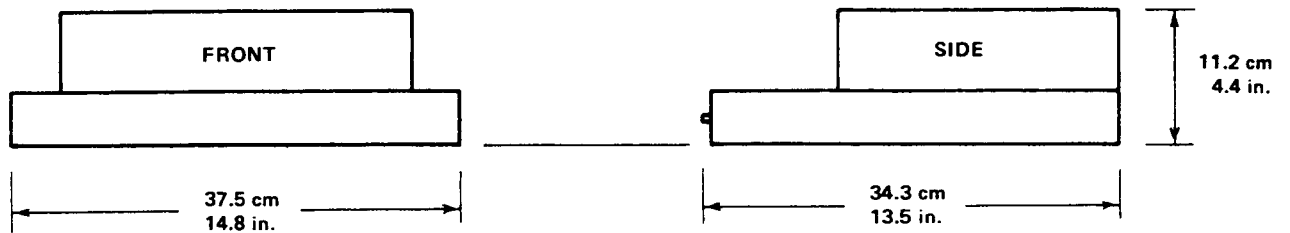

Figure 2-1. Overall dimensions.

2.1 UNPACKING AND INSPECTION.

If the shipping carton is damaged, ask that the carrier's agent be present when the instrument is unpacked. Inspect the instrument for damage (scratches, dents, broken parts, etc.). If the instrument is damaged or fails to meet specifications, notify the carrier and the nearest GenRad field office. (See list at back of this manual). Retain the shipping carton and the padding material for the carrier's inspection.

2.2 DIMENSIONS

Figure 2-1.

The instrument is supplied in the bench configuration, i.e., in a cabinet with resilient feet for placement on a table. The overall dimensions are given in the figure.

2.3 POWER-LINE CONNECTION.

The power transformer primary windings can be switched, by means of the line voltage switch on the rear panel, to accommodate ac line voltages in either of 2 ranges, as labeled, at a frequency of 50 or 60 Hz, nominal. Using a small screwdriver, set this switch to match the measured voltage of your power line.

If your line voltage is in the lower range, connect the 3-wire power cable (P/N 4200-9625) to the power connector on the rear panel (Figure 1-2) and then to the power line.

The instrument is fitted with a power connector that is in conformance with the International Electrotechnical Commission publication 320. The 3 flat contacts are surrounded by a cylindrical plastic shroud that reduces the possibility of electrical shock whenever the power cord is being unplugged from the instrument. In addition, the center ground pin is longer, which means that it mates first and disconnects last, for user protection. This panel connector is a standard 3-pin grounding-type receptacle, the design of which has been accepted world wide for electronic instrumentation. The connector is rated for 250 V at 6 A. The receptacle accepts power cords fitted with the Belden type SPH-386 connector.

The associated power cord for use with that receptacle, for line voltages up to 125 V, is Gen Rad part no. 4200-9625.

It is a 210-cm (7 ft), 3-wire, 18-gage cable with connector bodies molded integrally with the jacket. The connector at the power-line end is a stackable hammerhead design that conforms to the "Standard for Grounding Type Attachment Plug Caps and Receptacles," ANSI C73. 11-1966, which specifies limits of 125 V and 15 A. This power cord is listed by Underwriters Laboratories, Inc., for 125 V, 10 A.

If the fuse must be replaced, be sure to use a "slow blow" fuse of the current and voltage ratings shown on the rear panel, regardless of the line voltage.

If your line voltage is in the higher range selectable by the line voltage switch, use a power cord of the proper rating (250 V, 15 A) that mates with both instrument and your receptacle. It is possible to replace the "hammerhead" connector on the power cord that is supplied with a suitable connector. Be sure to use one that is approved for 250 V, 15 A. A typical configuration is shown in Figure 2-2.

2.4 LINE-VOLTAGE REGULATION

The accuracy of measurements accomplished with precision electronic test equipment operated from ac line sources can often be seriously degraded by fluctuations in primary input power. Line-voltage variations of +/-15% are commonly encountered, even in laboratory environments.

Although most modern electronic instruments incorporate some degree of regulation, possible power source problems should be considered for every instrumentation setup. The use of line-voltage regulators between power lines and the test equipment is recommended as the only sure way to rule out the effects on measurement data of variations in line voltage.

2.5 TEST-FIXTURE CONNECTIONS.

2.5.1 Test Fixture on the Digibridge.

Because an unusually versatile test fixture is provided on the front shelf of the instrument, no test-fixture connection is generally required. Simply plug the device to be measured (DUT) into the test fixture, with or without its adaptors. For details, refer to paragraphs 3.1, 3.2. Accessories can be attached to extend and adapt the test fixture, as described below.

2.5.2 Remote Test Fixture.

Connection of the DUT at a remote test fixture requires proper adaptors and cable connections from the Digibridge. Obtain the following accessories. (See Table 1-3.)

- BNC Adaptor 1689-9601
- BNC Cable Assembly 1689-9602, or equivalent
- Remote Test Fixture 1689-9600, or equivalent handler or special fixture.

This remote test fixture functions like the one supplied on the Digibridge. True "Kelvin" connections are made at the points of contact with the DUT leads. Install as follows:

- a. Remove any adaptors, if present, from the test fixture.
- b. Plug the BNC adaptor into the basic test fixture with the BNC connectors facing forward. Lock the connection with the 2 captive thumb screws. (The screws must be seated to complete the ground connection.)
- c. Connect the cable assembly to the adaptor on the Digibridge and to the remote test fixture as indicated in Table 2-1.

NOTE

User provided cables and/or remote test fixtures can be used, particularly if the DUT is to be handled automatically. See paragraph 3.7 for comments on cable and fixture capacitance.

2.5.3 The 1657-9600 Extender Cable (Banana Plugs).

The accessory extender cable 1657-9600 is available to connect to DUTs that are multiterminal, physically large, or otherwise unsuited for the built-in test fixture. This cable is particularly convenient for connecting multiterminal components with binding posts that accommodate banana plugs. Use the following procedure to install the extender cable on the instrument.

- a. Remove the adaptors, if present, from the test fixture.
- b. Plug the single-connector end of the extender cable into the Digibridge test fixture so that its blades enter both slots and the cable lies away from the display panel. Lock the connector with the two captive thumb screws.
- c. Note the color coding of the five banana plugs. Be sure that the "low" terminals (both potential and current) connect to one end of the DUT and the "high" terminals to the other end. Connect guard to a shield if any, but not to either end of the DUT.

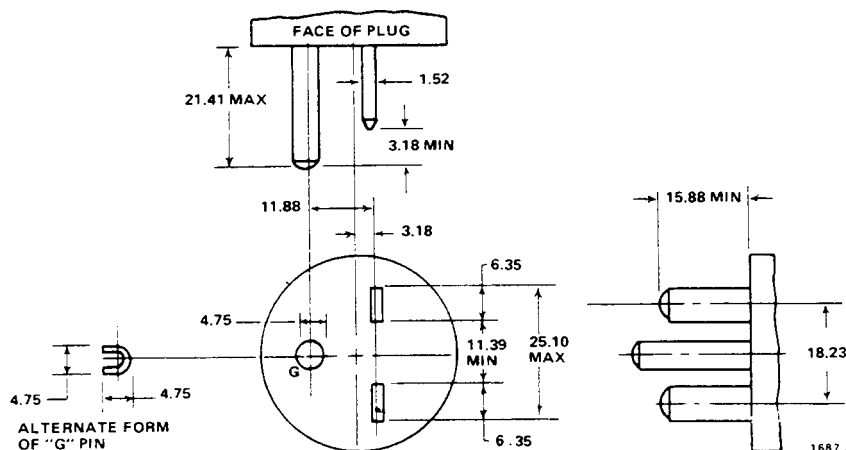

Figure 2-2. Configuration of 250-V, 15-A plug. Dimensions in mm. This is listed as NEMA 6-15P. Use for example Hubbell plug number 5666.

Table 2-1
TEST FIXTURE CONNECTIONS VIA BNC ADAPTOR 1689-9601

Test-Circuit Function	BNC Connector on 1689-9601 (at Digibridge)	Color Code in 1689-9602 Cable	Connection* at 1689-9600 Test Fixture (Remote)
I- (current, low) P- (potential, low)	I _L , Left P _L , Left-center	Black Black/white	I-, Right P-, Right-center
P+ (potential, high) I+ (current, high)	P _H , Right-center I _H , Right	Red/white Red	P+, Left-center I+, Left

*Left and right are defined with the fixture oriented for right reading of legend.

P-(potential, low) = Black/white
I-(current, low) = Black
P+(potential, high) = Red/white
I+(current, high) = Red
Guard = Black/green

Notice that the 2 wires with red must connect to the same end of the DUT, through a coaxial tee if the DUT is a 2-terminal device; the 2 wires labeled with black, connect to the other end, similarly. Connect the outer (shield) contacts to the shield or case of the DUT only if it is isolated from both ends of the DUT.

2.5.4 The 1688-9600 Extender Cable ("Type 874" Connectors).

The accessory extender cable 1688-9600 can be used to connect a DUT that is multiterminai, physically large, or otherwise unsuited for the built-in test fixture. This low-capacitance cable is used, for example, to connect type-874 connected impedance standards or a special test fixture. Make connections as follows:

- Remove the adaptors, if present, from the test fixture.
- Plug the single-connector end of the extender cable into the Digibridge test fixture so that its blades enter both slots and the cable lies away from the display panel. Lock the connector with the two captive thumb screws.
- Using the branched end of the cable, connect to the DUT with careful attention to the following color code.

The cable tips are type 874 coaxial connectors, which mate with a broad line of components and adaptors.

EXTENDER CABLE COLOR CODE
 RED AND RED: I+, current drive to "high" end of DUT.
 RED AND WHITE: P+, potential connection to same.
 BLACK AND BLACK: I-, current return at DUT "low".
 BLACK AND WHITE: P-, potential connection to same.
 OUTER CONTACTS: G, guard connection to shield or case.

2.6 EXTERNAL BIAS.

Figure 2-3.

WARNING

To minimize electrical shock hazard, limit bias to 30V.
 Bias voltage is present at connectors, test fixtures and on capacitors under test.
 Capacitors remain charged after measurement.
 Do NOT leave instrument unattended with bias applied.

Full bias voltage appears on test leads, bias-voltagesource terminals, and on the leads of the component being measured. Capacitors that have been charged are dangerous until properly discharged; the user must follow safe procedures to assure discharge. For safety, all personnel operating the instrument with bias must be aware of the hazards, follow safe procedures, and never leave the equipment unattended with bias voltage applied.

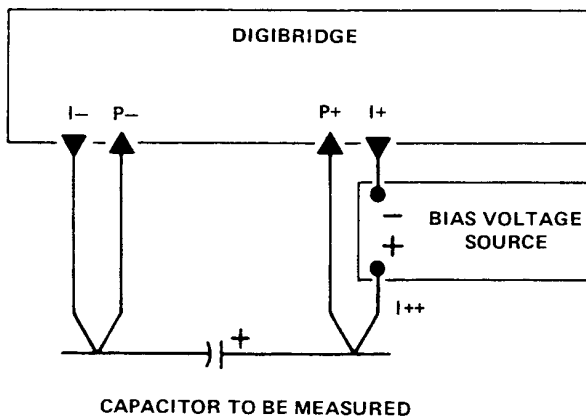

Figure 2-3. Connection of a bias voltage source to enable measurement of capacitors with bias applied. Because the measurement current (up to 30 mA rms) must pass through the bias source, it must be capable of being both source and sink for peaks of about 45 mA. Observe the voltage limits and procedural warnings in the text. Refer to the text also for discharge circuitry.

2.6.1 Basic Bias Connections.

In order to measure a capacitor with dc bias voltage applied, connect an external voltage source, as follows:

- Attach the remote test fixture or an extender cable as described in paragraph 2.5. Observe the color coding explained there.

b. Connect a suitable bias voltage source (see below) in series with the I+ connection, basically as shown in the diagram, with the following details.

With the Remote Test Fixture. Disconnect the red coded BNC cable end from the remote test fixture and connect one end of plain BNC cable there instead.

Connect the red coded BNC cable end to the negative terminal of the bias voltage source. Connect the remaining free end of the plain BNC cable to the positive terminal of the bias voltage source. Connect the DUT to the test fixture in the usual way.

With 1657-9600 Extender Cable (Banana Plugs). Connect the red banana plug to the negative terminal of the bias voltage source. Connect a suitable banana plug patch cord to the positive terminal. We designate the free end of this patch cord as I++, as shown in the diagram.

With 1688-9600 Extender Cable ("Type 874 Connectors").

Connect the "red and red" cable to the negative terminal of the bias voltage source. Connect a suitable type-874 patch cable to the positive terminal. We designate the free end of this patch cable as I++, as shown in the diagram.

c. If either of the extender cables (not the remote test fixture) is used, connect the DUT as follows. If capacitance is large (range 1), make 2 connections to each capacitor terminal (Kelvin connections). That is, I- and P- to capacitor negative terminal; P+ and I++ to capacitor positive terminal.

If the capacitance is smaller (range 2 or 3) the banana plugs can be stacked or a tee used with type-874 connectors and a single connection made to each capacitor terminal: I- /P- to the negative terminal, P+/I++ to the positive.

To make 3-terminal (or 5-terminal) measurements, also connect guard (see paragraph 2.5) to the guard terminal, shield, case, or ground of the capacitor, provided that this is insulated from the 2 main terminals of the capacitor. Do not connect guard to the case of a capacitor if the case is one of its 2 main terminals.

2.6.2 Bias Voltage Source Description

The bias voltage source must satisfy several criteria:

1. Supply the desired terminal voltage (dc)
2. Serve as source for charging current.
3. Serve as source and sink for the measuring currents (ac), which are 45, 0.45, and .0045 mA, peak, for measurements on ranges 1, 2, and 3, respectively.
4. Present a low, linear terminal impedance ($\ll 10$ ohms) at measuring frequency.

If the bias voltage source is a regulated power supply with the usual characteristic that it functions properly only as a source, not a sink, then the following test setup is

recommended. Connect across the power supply a bleeder resistor that draws dc current at least as great as the peak measuring current (item 3 above). In parallel with the bleeder, connect a 100-pF capacitor. (If the power supply has exceptionally good transient response, the capacitor is not necessary.)

No single bleeder resistor will suffice for all bias conditions, so it may be necessary to switch among several. Each resistance must be small enough to keep the power supply regulator current unidirectional (as mentioned above) for the smallest bias voltage in its range of usefulness. Also the resistance and dissipation capacity must be large enough so that neither the power supply is overloaded nor the resistor itself damaged for the highest bias voltage in its range of application.

NOTE

For convenience, a suitable active current sink can be used in lieu of bleeder resistors.

A discharge circuit is also required. (Do not depend on the above-mentioned bleeder resistor.) A dual discharge circuit is recommended. Connect a clip lead with a $10\text{-}\Omega$ resistor in series and another plain clip lead to the I-/Pjunction. Provide the loose ends of these with insulated alligator clips for use when completing the discharge path across the DUT. For a recommended procedure, refer to para 3.6.

If the measurement program warrants the expense of a test fixture for biased-capacitor measurements, its function should be equivalent to that of the circuit described above. It should be equipped with convenient switching to remove the bias source, discharge through $10\ \Omega$, and finally to short out the capacitor after measurement. For automated test setups, it is also feasible to precharge the capacitors before they are attached to the test fixture and to discharge them after they have been removed.

CAUTION

To avoid damage to the instrument, limit the bias voltage to 30 V, maximum, in any precharging bias supply, used as mentioned above.

2.7 ENVIRONMENT.

The Digibridge can be operated in nearly any environment that is comfortable for the operator. Keep the instrument and all connections to the parts under test away from electromagnetic fields that may interfere with measurements.

Refer to the Specifications at the front of this manual for temperature and humidity tolerances. To safeguard the instrument during storage or shipment, use protective packaging. Refer to Section 5.

Operation – Section 3

3.1 BASIC PROCEDURE	3-2
3.2 CONNECTION OF DUT	3-3
3.3 FUNCTION AND RANGE SELECTIONS	3-3
3.4 ACCURACY	3-4
3.5 PARALLEL/SERIES AND FREQUENCY SELECTIONS	3-6
3.6 BIAS	3-7
3.7 CORRECTION FOR CABLE	3-8

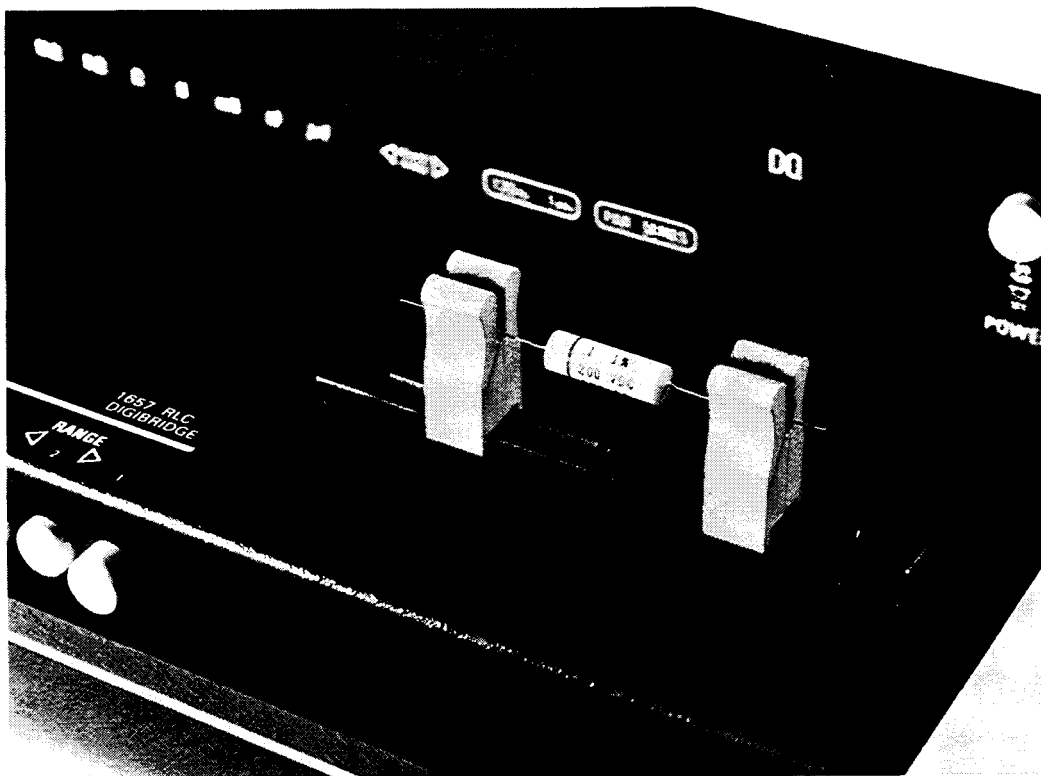

Figure 3-1. Use of the test fixture adaptors.

3.1 BASIC PROCEDURE.

For initial familiarization, follow this procedure carefully. For details, refer to later paragraphs in Operation.

a. Before connecting the power cord, slide the linevoltage switch (rear panel) to the position that corresponds to your power-line voltage. Power must be nominally either 50 or 60 Hz ac, either 120 or 220 V. (Refer to specifications at front of this manual.) The 1657-9700 can be run on 50 Hz but with some loss of accuracy for 120-Hz measurements in high range extensions. Similarly, the 1657-9800, if run on 60-Hz power, experiences some extraneous noise in 100Hz measurements in high range extensions.

If the fuse must be replaced, be sure to use a "slow blow" fuse of the rating shown on the rear panel.

b. Connect a typical device, whose impedance is to be measured, as follows. (This device under test is denoted DUT.)

NOTE

Clean the leads of the DUT if they are noticeably dirty, even though the test-fixture contacts will usually bite through a film of wax to provide adequate connections.

Radial-lead DUT: Insert the leads into the test fixture slots as shown in the photograph, Figure 1-1. For details of wire size and spacing limits, refer to para 3.2.

Axial-lead DUT: Install the test-fixture adaptors, supplied, one in each slot of the test fixture, as shown in the accompanying figure. Slide the adaptors together or apart so the body of the DUT will fit easily between them. Press the DUT down so that the leads enter the slots in the adaptors as far as they go easily. For details of wire size and DUT size limits, refer to para 3.2.

NOTE

To remove each adaptor, lift with a gentle tilt left or right. For a DUT with very short leads it is important to orient each adaptor so its internal contacts (which are off center) are close to the DUT.

Other DUTs, Remote Connections, and Bias.

For connections via extender cables and remote test fixtures, refer to the installation instructions of paragraph 2.5. For connection of bias voltage and operating procedures with bias, refer to paragraphs 2.6 and 3.6. For convenience, the typical color coding used in extender cables is repeated below.

Red: I+, current connection to "high" end of DUT. .

Red & white: P+potential connection to same.

Black: I-, current connection to low end of DUT. .

Black & white: P-, potential connection to same

Black & Green: G, guard connection to shield or case (if isolated from the preceding terminals). Do not-connect G to the case of a capacitor if the case serves as (or is connected to) one of its 2 main terminals.

Figure 3-1.

Notice that the 2 red tips must connect to the same end of the DUT. The terminals with white bands are potential connections; with no bands, current terminals.

c. Set the pushbuttons according to the desired measurement, as follows:

Power. Depress the POWER button so that it stays in the depressed position. (To turn the instrument off, push and release this button so that it remains in the released position.)

Function. For resistance, depress R. For inductance, depress L/Q. For capacitance, depress C/D. Be sure that one of these buttons is in the depressed position.

Frequency. For measurement at 1 kHz, push and release the FREQUENCY button until the 1-kHz light comes on. For 120 (100) Hz, push the same button so that the 120-Hz (100.Hz) light comes on.

Parallel or Series. For series equivalent circuit, push and release the PARALLEL/SERIES button until the SERIES light comes on. For parallel equivalent circuit, push this button so that the PARALLEL light comes on. (The choice is significant for lossy capacitors or inductors, not for lowloss reactive components or non-reactive resistors.) For further explanation, refer to para 3.5.

Range. Depress the middle (RANGE-2) button first and watch the ADJUST RANGE lights. If the right-pointing arrow is lighted, depress RANGE button at the right. If the left-pointing arrow is lighted, depress RANGE button at the left. When neither arrow is lighted, the range you have selected is correct. (Be sure that one of the RANGE buttons is in the depressed position.) Additional comments on range choices are below.

d. Read the measurement on the main displays. The R LC display is the principal measurement, complete with decimal point and units, which are indicated by the light spot behind M, k, , H, mH, nF, or uF.* The DQ display is D if the C/D FUNCTION button is in, Q if the L/Q button is in.

e. After any change in DUT or measurement conditions, before looking at the displays, notice the ADJUST RANGE lights. Interpret them as follows:

Neither light. Correct range. (There are minor exceptions.)

Left Light. Wrong range; try next RANGE button to left.

Right Light. Wrong range; try next RANGE button to right.

Both Lights. Overrange or invalid display. If FUNCTION is correct and RANGE is highest, the measurement is valid but because of an overrange condition, the basic 0.2% accuracy cannot be guaranteed. (If you switch to RANGE 2, one of the lights will go out.) If both lights are lit on RANGE 2, either the FUNCTION is inappropriate for the DUT or it is not properly connected. For more details, refer to para 3.3.

*If the extender cable is used, it may be necessary to correct for its capacitance.

3-2 OPERATION

3.2 CONNECTION OF THE DUT.

3.2.1 The Integral Test Fixture.

The test fixture provided on the front ledge of the Digi

bridge provides convenient, reliable, guarded 4-terminal connection to any common radial-lead or axial-lead component.

If the slots of your test fixture have rounded ends, the slots accommodate wires of any diameter from 0.25 mm (.01 in., AWG 30) to 1 mm (.04 in., AWG 18), spaced from 6 to 98 mm apart (0.23 to 3.9 in.) or equivalent strip conductors. Each "radial" wire must be at least 1 cm long (0.4 in.). However, if the slots of your test fixture have square ends, they will accommodate wires spaced as close as 4 mm (0.16 in.) and each "radial" wire must be at least 4 mm (0.16 in.) long. The divider between the test slots contains a shield, at guard potential, with its edges exposed. The adaptors accommodate wires of any diameter up to 1.5 mm (.06 in., AWG 15). The body of the DUT that will fit between these adaptors can be 80 mm long and 44 mm diameter (3.1x1.7 in.) maximum. Each "axial" wire must be at least 3 mm long (0.12 in.).

For radial-lead parts, remove each adaptor from the test fixture by a gentle pull upward, made easier by bending the adaptor left or right (never forward or back). For axial-lead parts, insert the adaptors, one in the left slot and the other in the right slot of the test fixture, by pushing vertically downward. They can be slid left and right to match the length of DUT to be measured. Notice that the contacts inside the adaptor are off center; be sure to orient the adaptors so the contacts are close to the body of the DUT, especially if it has short or fragile leads.

Insert the DUT so one lead makes connection on the left side of the test fixture, the other lead on the right side. Insertion and removal are smooth, easy operations and connections are reliable if leads are clean and straight.

Be sure to remove any obvious dirt from leads before inserting them. Be sure the contact pair inside each half of the test fixture is held open by a single item ONLY, whether that is one lead of an axial-lead DUT or one adaptor, to obtain true "Kelvin" connections.

3.2.2 Test Fixture Accessories.

An accessory extender cable or adaptor, cable, and remote test fixture, as described in Table 1-3, is needed to connect any DUT that is multiterminal, physically large, or otherwise unsuited for the built-in test fixture.

A cable is needed, for example, to connect impedance standards, a remote test fixture, capacitors to be measured with bias, etc. For connection to the instrument, refer to paragraph 2.5. For measurements with bias, refer to paragraphs 2.6 and 3.6. The color code for the branched end of each cable is given in paragraph 3.1. To correct for cable capacitance, refer to paragraph 3.7.

3.3 FUNCTION AND RANGE SELECTIONS.

3.3.1 Function Pushbuttons.

The selection of the principal parameter to be measured is almost self-explanatory. Depress the appropriate FUNCTION button: R, L/Q or C/D to measure resistance, inductance, or capacitance. The instrument will tolerate, to some degree, a poor choice of function, but accuracy is thereby reduced. The readout will indicate a completely wrong choice of function, as explained below. Notice that the appearance of a device can be misleading. (For example, a faulty inductor can be essentially capacitive or resistive; a component part can be mislabeled or unlabeled.)

If both ADJUST RANGE lights are on, the RANGE 2 button is in, the RLC display is blank, and the DUT is properly connected, then the choice of function is probably wrong. Most likely, if the L/Q button is in, the DUT is capacitive; or if the C/D button is in, the DUT is inductive.

Observe the DQ display for an indication of poor choice of function (though tolerable). Large D or small 0 may indicate that the "reactor" being measured is practically a resistor at the measuring frequency. If the C/D button is in and the D reading is between 1 and 10 (or blank, as it will be for $D > 10$) it is possible that the DUT is enough like a resistor to be measured best with the R button in. Similarly, if the L/Q button is in and the Q reading is between zero and 1, it is possible that the DUT is enough like a resistor to be measured best with the R button in. Notice that when the R button is in, the DO display is always blank. On the other hand, any D or Q display is valid, even if the "wrong" function has been selected. (The C or L display can be blank.)

If the R button is in (a resistor is being measured) the easy way to determine whether the DUT is reactive is to try making C/D and L/Q measurements. If you obtain a valid C measurement with $D < 1$, the DUT is capacitive. The smaller this D value, the less accurate the R measurement. Similarly, if you obtain a valid L measurement with $Q > 1$, the DUT is inductive. The larger this Q value the less accurate the R measurement. (See para 3.4.)

3.3.2 Range Pushbuttons.

Range selection is also nearly self-explanatory. Follow the ADJUST RANGE lights. The left light means: "Push the next range button to the left." The right-hand light means: "Push the next range button to the right." Continue until both lights go out. The instrument will usually display a measurement (at reduced accuracy) even though the range is not optimum. The following details about range are best understood with reference to para 3.4 (particularly the RLC basic accuracy graph).

The RANGE buttons are placed in order of decreasing impedance, 3-2-1. The "highest" range is therefore Range 1 for C/D; but it is Range 3 for R and L/Q.

Table 3-1
FULL SCALE READOUTS ON EACH SUBRANGE

Manual range	Automatic subrange	R		L		C	
		1 kHz	120 (100) Hz	1 kHz	120 (100) Hz	1 kHz	120 (100) Hz
1 (Z ₀ = 10 Ω)	1A	19.999 Ω	19.999 Ω	1.9999 mH	19.999 mH	19.999 μF	199.99 μF
	1B*	999.99 Ω	999.99 Ω	99.999 mH	999.99 mH	999.99 μF	9999.9 μF
	1C**	-----	-----	-----	-----	-----	99999. μF
2 (Z ₀ = 1 kΩ)	2A	1.9999 kΩ	1.9999 kΩ	.19999 H	1.9999 H	.19999 μF	1.9999 μF
	2B*	99.999 kΩ	99.999 kΩ	9.9999 H	99.999 H	9.9999 μF	99.999 μF
3 (Z ₀ = 100 kΩ)	3A	.19999 MΩ	.19999 MΩ	19.999 H	199.99 H	1.9999 nF	19.999 nF
	3B*	9.9999 MΩ	9.9999 MΩ	999.99 H	9999.9 H	99.999 nF	999.99 nF
	3C**	-----	99.999 MΩ	-----	-----	-----	-----

* Each "B" subrange covers a full decade (example, 20 to 200 Ω) in the basic range and an upper range extension (example 200 to 999 Ω), in which accuracy is reduced and the ADJUST RANGE light(s) is on.

** Each "C" subrange is a further extension of the highest range (example, 10 to 99.9⁺ MΩ).

Each basic range is slightly more than 2 decades wide, from an R LC display of 01900, with an automatic decimal point change between the decades, to 19999. (The symbol 0 represents a blanked zero. Initial zeroes to left of the decimal point are always blanked out of the RLC display.) Each of the 3 ranges goes beyond its basic range, with both upper and lower range extensions (shown by lighter lines in the RLC basic accuracy graph). Several of these extensions are seldom used because they overlap "basic" portions of other ranges and because the operator is alerted to this fact by an ADJUST RANGE light.

Each range includes 2 or 3 subranges, distinguished by the automatic decimal-point shift. The operator does NOT control them. Subranges are detailed in Table 3-1. Notice, for example, if you select RANGE 1, C/D, 1 kHz, then there are 2 subranges: 19uF and 999uF. If a series of measurements is made with C increasing slowly above 19uF, the automatic subrange change takes place at 21. But with C decreasing, the change takes place at 20. This hysteresis eliminates a possible cause of flickering of the display.

The "low" extension of each range goes from 01900 down to 00000, without any change in decimal point, but with reduced accuracy. The number of digits in this display is always adequate for the specified accuracy. Any measurement in the low extension of either Range 2 or the highest range causes the appropriate ADJUST RANGE arrow to be lighted. But there is no such light in the low extension of the lowest range (because there is no lower range to select).

The "high" extension of each range is a factor of 5 (with 2 exceptions), going from 19999 up to 99999, and finally to blank, without any change in decimal point, but with reduced accuracy. Any measurement in the high extension of either the lowest range or Range 2 causes the appropriate ADJUST RANGE arrow to be lighted. However in

3-4 OPERATION

the high extension of the highest range, both ADJUST RANGE arrows are lighted (to indicate a useful "overrange" condition).

The high extension of the top range for Rand C only, at 120 Hz (100 Hz) only, is a factor of 50, going from 19999, with an automatic decimal-point change, up to 99999, and finally to blank, with reduced accuracy. (Both ADJUST RANGE arrows are lighted as described above.)

A special case warrants explanation. (This is a minor exception to the basic procedure of para 3.1.) It is possible

for both ADJUST RANGE lights to be out and yet the RANGE and FUNCTION buttons to be incorrectly set.

This condition result's from either faulty connection to the DUT or a numerically small negative Lor C measurement. Sometimes a loose or dirty connection to the DUT causes

an erratic RLC display. A small negative L or C (wrong function selected) causes a zero display. In either case, check connections at the test fixture and try all 3 FUNCTIONS to see which is appropriate, R, L/Q, or C/D.

3.4 ACCURACY.

3.4.1 Graphs.

Figures 3-2, 3-3, and 3.4

The following accuracy graphs supplement the statement of accuracy in the specifications, at the front of this manual.

Figure 3.2 shows that the R LC basic accuracy of 0.2% is realized over 6 decades of impedance if the correct range is selected (as indicated by the ADJUST RANGE lights being out). The reduction of accuracy is shown for all of the "low" and "high" range extensions. This basic RLC accuracy is valid only for "pure" R, L, or C. For the effect

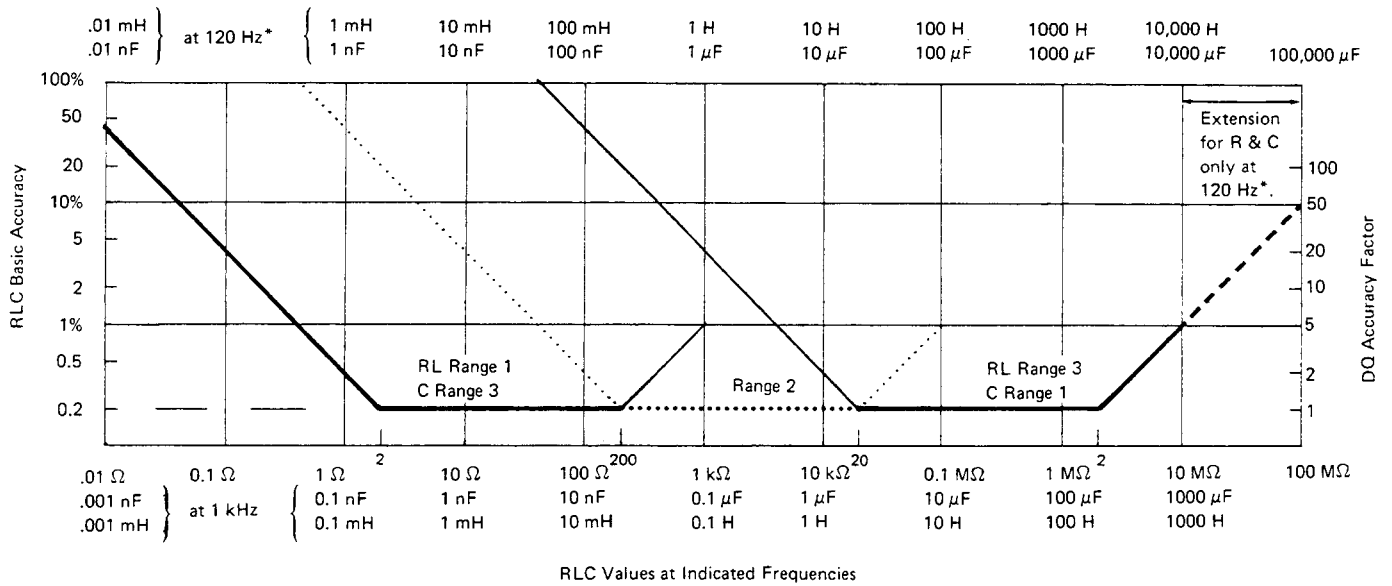

Figure 3-2. R L C basic accuracy as a percent of reading. Heavy lines (solid and dotted) represent best choice of range. Range 2 is dotted. Notice that Land C scales above graph are for 120 Hz (*equally valid for 100 Hz) and the 2 below graph are for 1 kHz. The DQ accuracy factor (right-hand scale) is the multiplier that, applied to the DQ Basic Accuracy, yields complete DQ accuracy, for range extensions as well as the basic ranges (where RLC accuracy is 0.2%).

of quadrature impedance, multiply each basic accuracy value by the RLC accuracy factor; *see* below.

Figure 3-3 shows the RLC accuracy factor, which depends on D or Q. For example, suppose a capacitor measured at 1 kHz has C = 400 uF and D = 0.5. The R L C basic accuracy is 0.4% and the R L C accuracy factor is 1.5. Therefore, the accuracy of the C measurement is $\pm 0.6\%$. Notice that the D or Q of a resistor (if significant) can be measured by selecting the C/D or L/Q FUNCTION.

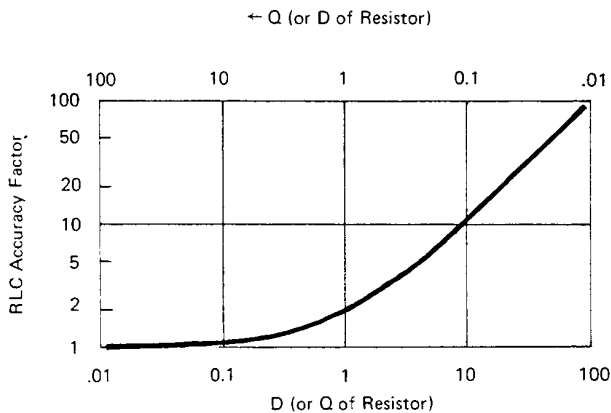

Figure 3-3. R L C accuracy factor as a function of D and Q. Multiply the RLC Basic Accuracy by this factor to obtain complete RLC accuracy for impedances that are not "pure" resistance or reactance. For capacitors and inductors, use the D and Q scales, respectively. For resistors, use the "D of Resistor" scale if capacitive, the "Q of Resistor" scale if inductive.

Figure 3-4 shows the basic DQ accuracy, which is simple function of D or Q. For D read the lower scale and lower curve. For Q read the upper scale and upper curve. The basic DQ accuracy is valid only if measurements are made on one of the 3 basic ranges (where RLC accuracy is best). Otherwise, multiply basic DQ accuracy by the DQ accuracy factor, shown on the right of the "RLC basic accuracy" graph. In the example of C = 400 uF, D = 0.5, the basic D accuracy is 0.5% and the D accuracy factor is 2. Therefore, the accuracy of the D measurement is $\pm 1\%$.

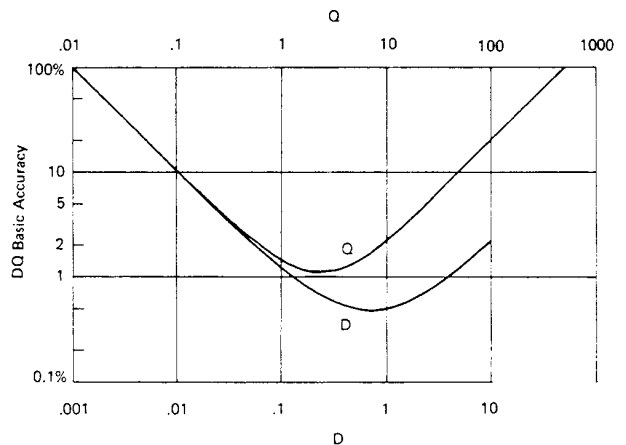

Figure 3-4. DQ basic accuracy as a percent of reading. These curves are directly applicable for measurements in the basic ranges. For measurements on any of the range extensions, refer also to Figure 3-2 for the DQ accuracy factor.

The logarithmic scales on these figures make it very easy to apply the accuracy factors *visually*. For example, suppose a capacitor is being measured on range 2, both ADJUST RANGE lights are out, and the D display is about 1. Figure 3-3 shows that the C accuracy factor is about 1/3 of a decade on the logarithmic scale. On Figure 3-2, find the heavy dotted line (the basic portion of range 2) and point to the basic C accuracy (0.2%) at the left. Now apply the C accuracy factor by moving the pointer up about 1/3 of a decade. The pointer now shows the corrected C accuracy, 0.4%.

3.4.2 Insignificant Digits.

One or more of the digits at the right end of the R LC and/or DQ displays may be insignificant. This is particularly true at the upper extension of a range. If there are more than one insignificant digits in a display, the least significant is typically noisy. That is, it will appear to flicker at random over a range of values and should be ignored.

For example, if you measure a 4-M resistor, the display might ideally be 4.1234 M ; but the one or two final digits might be changing at random. This flickering is entirely normal. The specified accuracy (+/-0.4%) is the key to expected performance; in this example, the last 2 digits are insignificant and the last digit is quite unnecessary. Typically, one would record this measurement as 4.12 +/-0.02 M .

3.5 PARALLEL/SERIES AND FREQUENCY SELECTIONS.

3.5.1 General.

The value of the principal measurement (R, L, or C) of a certain DUT depends on which of 2 equivalent circuits is chosen to represent it. (Many impedance measuring instruments provide no choice in the matter, but this one allows selection.) The more nearly "pure" the resistance or reactance, the more nearly identical are the "series" and "parallel" values. However, for D or 0 near unity, the difference is substantial. Also, the principal measurement often depends on measurement frequency. The more nearly "pure" the resistance or reactance, the less is this dependence. However, for D or Q near unity and/or for measuring frequency near the self-resonant frequency of the DUT, this dependence is quite substantial. We first give general rules for selection of measurement parameters, then some of the theory.

3.5.2 Rules.

Specifications. The manufacturer or principal user of the DUT probably specifies how to measure it. (Usually "series" is specified for C, L, and low values of R.) Select "parallel" *or*: "series" and 1 kHz or 120 Hz (100 Hz) according to the applicable specifications. If there are none known, be sure to

specify with your results whether they are "parallel" or "series" and what the measurement frequency was.

Resistors, below about 1 k : Series, 120 Hz (100 Hz). Usually the specifications call for dc resistance, so select a low test frequency to minimize ac losses. Select "series" because the reactive component most likely to be present in a low-resistance resistor is series inductance, which has no effect on the measurement of series R. As a quick check on whether the DUT is nearly pure resistance, make a separate "parallel" measurement. Rp will be larger than Rs. If the difference is less than 1 %, then 0 is less than 0.1, and the measured Rs is probably very close to the dc resistance.

Resistors, above about 1 k : Parallel, 120 Hz (100 Hz). As explained above, select a low test frequency. Select "parallel" because the reactive component most likely to be present in a high-resistance resistor is shunt capacitance, which has no effect on the measurement of parallel R. As a quick check on whether the DUT is nearly pure resistance, make a separate "series" measurement. If the difference between Rp and Rs is less than 1%, then D is greater than 10, and the measured Rp is probably very close to the dc resistance.

Capacitors below 2 nF: Series, 1 kHz. Unless otherwise specified or for special reasons, always select "series" for capacitors and inductors. This has traditionally been standard practice. Select a high measurement frequency for best accuracy.

Capacitors above 200 uF: Series, 120 Hz (100 Hz). Select "series" for the reasons given above. Select a low measurement frequency for best accuracy and to enable measurement of capacitors larger than 1000uF.

Inductors below 2 mH: Series, 1 kHz. Select "series" as explained above. Select a high measurement frequency for best accuracy.

Inductors above 200 H: Series, 120 Hz (100 Hz). Select "series" as explained before. Select a low measurement frequency for best accuracy and to enable measurement of inductors larger than 1000 H.

3.5.3 Series and Parallel Parameters.

Figure 3-5.

An impedance that is neither a pure reactance nor a pure resistance can be represented at any specific frequency by either a series or a parallel combination of resistance and reactance. Keeping this concept in mind will be valuable in operation of the instrument and interpreting its measurements. The values of resistance and reactance used in the equivalent circuit depend on whether a series or parallel combination is used. The equivalent circuits are shown in Figure 3-5. The relationships between the various circuit elements are as follows.

Resistance and Inductance

$$Z = R_s + j\omega L_s \quad Z = \frac{j\omega L_p R_p}{R_p + j\omega L_p} \quad Z = \frac{R_p + jQ^2 \omega L_p}{1 + Q^2}$$

$$Q = \frac{1}{D} \quad Q = \frac{\omega L_s}{R_s} \quad Q = \frac{R_p}{\omega L_p}$$

$$L_s = \frac{Q^2}{1 + Q^2} L_p \quad L_s = \frac{1}{1 + D^2} L_p$$

$$L_p = \frac{1 + Q^2}{Q^2} L_s \quad L_p = (1 + D^2) L_s$$

$$R_s = \frac{1}{1 + Q^2} R_p \quad R_p = (1 + Q^2) R_s$$

$$R_s = \frac{\omega L_s}{Q} \quad R_p = Q\omega L_p \quad R_p = \frac{1}{G_p}$$

Resistance and Capacitance

$$Z = R_s + \frac{1}{j\omega C_s} \quad Z = \frac{R_p}{1 + j\omega R_p C_p} \quad Z = \frac{D^2 R_p + 1/(j\omega C_p)}{1 + D^2}$$

$$D = \frac{1}{Q} \quad D = \omega R_s C_s \quad D = \frac{1}{\omega R_p C_p}$$

$$C_s = (1 + D^2) C_p \quad C_p = \frac{1}{1 + D^2} C_s$$

$$R_s = \frac{D^2}{1 + D^2} R_p \quad R_p = \frac{1 + D^2}{D^2} R_s$$

$$R_s = \frac{D}{\omega C_s} \quad R_p = \frac{1}{\omega C_p D} \quad R_p = \frac{1}{G_p}$$

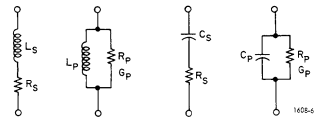

Figure 3-5. Equivalent circuits for a lossy inductor and a lossy capacitor.

3.5.4 Equivalent Series R for Capacitors.

The total loss of a capacitor can be expressed in several ways, including D and "ESR." To obtain equivalent series resistance, one can measure directly (if D is high enough to permit the desired accuracy) or calculate.

Direct Measurement. If, while measuring C, you observe that D is above 0.1 (or some other limit of your choice, see Figure 3-3), push FUNCTION button R and select SERIES.

Both C and ESR should be measured on the same range. If D is below 1, the range should be correct for C, even though the ADJUST RANGE light comes on while you measure ESR. However, if D is above 1, choose the correct "R" range to obtain ESR; and then remeasure C on this range.

Calculation. If D is small, it is better to calculate "ESR" as follows: $R_s = D/2 \text{ fCs}$ where $f = 3.1416$. D and Cs are displayed on the front panel. Frequency f depends on the model of the instrument and the selected frequency as follows (+/- .01%):
 1657-9700: "1 kHz" is 1020.0 Hz; "120 Hz" is 120.0 Hz. 1657-9800: "1 kHz" is 1000.0 Hz; "100 Hz" is 100.0 Hz.

"Equivalent series resistance" is typically much larger than the "ohmic" resistance of the wire leads and foils that are physically in series with the heart of a capacitor. ESR includes also the effect of dielectric loss and is therefore dependent on frequency.

3.5.5 Parallel Equivalent Circuits for Inductors.

Even though it is customary to measure series inductance of inductors, there are situations in which the parallel equivalent circuit better represents the physical device. At low frequencies, the significant loss mechanism is usually "ohmic" or "copper loss" in the wire and the series circuit is appropriate. If there is an iron core, at higher frequencies the significant loss mechanism may be "core loss" (related to eddy currents and hysteresis) and the parallel equivalent circuit is appropriate. Whether this is true at 1 kHz should be determined by an understanding of the DUT, but probably it is so if the following is true: that measurements of Lp at 1 kHz and at 120 Hz (100 Hz) are more nearly in agreement than measurements of Ls at the same 2 frequencies.

3.6 BIAS.

To measure a capacitor with bias applied, it is necessary to insert a bias voltage source in series with the I+ lead to the DUT and to provide a means of discharging it. Refer to para 2.6 for installation of the recommended circuit.

WARNING

To minimize shock hazard, limit bias to 30 V.
Bias voltage is present at connectors, test fixtures and on capacitors under test.
Capacitors remain charged after measurement.
Do not leave instrument unattended with bias applied.

Although special precautions are not required, we recommend the following procedure, to assure controlled conditions for both charging and discharging capacitors.

- a. Set the bias voltage to zero.
- b. Attach the DUT, with correct polarity.
- c. Raise the bias voltage to the specified value.
- d. Allow a specified charging and soaking time.
- e. Observe and record the specified measurements (usually Cs and D).
- f. Set the bias voltage source to zero.
- g. Connect the 10-n discharging circuit.
- h. After about 2 s, connect the safety short circuit.
- i. Remove the DUT and the discharging circuits.

3.7 CORRECTION FOR TEST FIXTURE ACCESSORIES.

3.7.1 With the Remote Test Fixture.

The remote test fixture, cable assembly, and adaptor (1689-9600, -9602, -9601) introduce about .001 nF of capacitance in parallel with the DUT, a generally negligible error. For the best accuracy, select PARALLEL, C/D, and range 3; measure the capacitance "Cc" with the remote test fixture open (no DUT). Then measure a DUT, PARALLEL, C/D; the RLC display is now $C_c + C_x$, where C_x is the capacitance of the DUT. Therefore, subtract the measured C_c from the RLC display to obtain C_x .

3.7.2 With the 1657-9600 Extender Cable (Banana Plugs).

The 1657-9600 extender cable introduces about .0002 nF of capacitance in parallel with the DUT, a negligible error. For very high precision, the following procedure can be used, determining a correction for measurements of parallel capacitance.

Because the physical arrangement and spacing of the cable branches and connectors is significant, a correction should be determined for each measurement setup. The following procedure applies to connection with a precision 3-terminal capacitor, GR 1404 or 1413, for example:

- a. Install an adaptor, GR 874-Q2, on each of the two coaxial connectors, Land H, of the capacitor.
- b. Connect cable branch G to the ground post of the "low" terminal adaptor. With a clip lead or plain wire, connect this point to the ground post of the "high" adaptor.
- c. Connect cable branch P- to the main post of the "low" adaptor and stack I- on top of P-.
- d. Similarly, connect P+, with I+ stacked on top of it, to the main post. of the "high" adaptor.
- e. Measure this total capacitance, the sum of the desired measurement and the cable capacitance, $C_x + C_c$.
- f. Carefully lift the stacked pair of cable tips, I+/P+, from the "high" adaptor and hold them about 0.5 cm (1/4 in.) above the binding post where they were connected.
Do NOT rearrange the cable branches or change their spacing more than is absolutely necessary to follow these directions. Hold the plastic tips (not the wires) and touch the guard (G) circuit firmly with a couple of fingers, to minimize the effect of capacitance in your body.
- g. Measure the cable capacitance, C_c .
- h. Subtract the result of step g from that of step e, to obtain the desired measurement, C_x .

3.7.3. With the 1688-9600 Extender Cable

("Type 874" Connectors).

The 1688-9600 extender cable introduces no parallel capacitance that can be resolved on the 1657 Digibridge, if the shielding between "high" and "low" is maintained consistently. For example, to connect a 3-terminal DUT having two type 874 connectors, use a type 874 tee for the red and red/white cables, and another type 874 tee for the black and black/white cables.

3.8 CARE OF DISPLAY PANEL.

Use caution when cleaning the display window, not to scratch it nor to get cleaning substances into the instrument. Use soft cloth or a ball of absorbent cotton, moistened with a mild glass cleaner, such as "Windex" (Drackett Products Co., Cincinnati, Ohio). Do NOT use a paper towel; do NOT use enough liquid to drip or run.

If it should be necessary to place marks on the window, use paper-based masking tape (NOT any kind of marking pen, which could be abrasive or react chemically with the plastic). To minimize retention of any gummy residue, remove the tape within a few weeks.

Theory – Section 4

4.1 INTRODUCTION.	4-1
4.2 PRINCIPAL FUNCTIONS.	4-2

4.1 INTRODUCTION.

4.1.1 General.

This instrument uses an unusual method of measurement, which is quite different from those used in previous impedance meters or bridges. A thorough understanding of this method will be helpful in unusual applications of the instrument. The following paragraph gives a brief overall description outlining the measurement technique to one familiar with impedance measurement methods. A more detailed description of operation, specific circuitry, and control signals is given later.

4.1.2 Brief Description of the 1657 Digibridge.

This Digibridge™ uses a new measurement technique, in which a microprocessor calculates the desired impedance parameters from a series of 8 voltage measurements.* These measurements include quadrature (90°) and inverse (180°) vector components of the voltage across the "unknown" impedance Z_x and the voltage across a standard resistor R_s carrying the same current as Z_x . Each of these measurements is meaningful by itself, because the current through Z_x is not controlled. But the 8 measurements are all made in rapid sequence with the same phase-sensitive detector and analog-to-digital converter. Therefore properly chosen differences between these measurements subtract out fixed offset errors, and ratios between the differences cancel out the value of the common current and the scale factor of the detector-converter.

The phase-sensitive detector uses 4 reference signals, precisely 90° apart, that have exactly the same frequency as the test signal, but whose phase relationship to any of the analog voltages (such as the 8 mentioned above) or currents (such as the current through Z_x and R_s) is incidental. Therefore, no precise analog phase shifter or waveform squaring circuit is required. Correct phase relationships are maintained by generating test signal and reference signals from the same high-frequency source.

There are no calibration adjustments in the Digibridge, thanks to the measurement technique. The only precision

components in this instrument are three standard resistors and a quartz-crystal stabilized oscillator. There is no reactance standard. For example, C and D are calculated by the microprocessor from the set of 8 voltage measurements and predetermined values of frequency and the applicable standard resistance.

The microprocessor also controls the measurement sequence, using programs in the ROM memory and a few manual selections. The desired parameters, C and D, $\tan \theta$, or R; equivalent circuit, unit, series or parallel; and frequency, either 120 Hz (100 Hz) or 1 kHz, are selected by front panel controls. There are also three manually selected ranges, which have wide overlap. The optimum range for any measurement is indicated by panel lights.

Each range is 2 decades wide, with reduced-accuracy extensions both above and below. For example, consider resistance measurement on Range 1 (Figure 3-2). The 2 decades extend from 02.000 Ω , with an automatic decimal-point shift at 02.100 going up (at 020.00, going down) to 200.00 Ω . The range extensions go as far as can be displayed without further decimal-point shifting: upwards to 999.99 Ω , downwards to 00.001 Ω . Leading zeroes before the decimal-point (0) are blanked out.

Test frequencies are within 2% of the front-panel indication. However, for reasons related to rejection of power-line-frequency stray signals that could be picked up by the DUT, thereby causing measurement errors, the actual frequencies are as follows --accurate to $\pm 0.01\%$ -

catalog number 1657-9700: 1020.0 Hz, 120.00 Hz
catalog number 1657-9800: 1000.0 Hz, 100.00 Hz.

4.1.3 Block Diagram.

Figure 4-1.

The block diagram shows the microprocessor (μP) in the upper right corner connected by data and address buses to digital circuitry including RAM and ROM memories, status and control latches, and the front-panel display.

Analog circuitry is shown in the lower part of the diagram, where Z_x is supplied with a test signal at frequency f from a sine-wave generator, driven by a crystal-controlled digital frequency divider circuit. The front-end amplifier circuit supplies an analog signal that represents 2 impedances alternately: the internal standard, R_s , and the DUT, Z_x .

*Patent applied for.

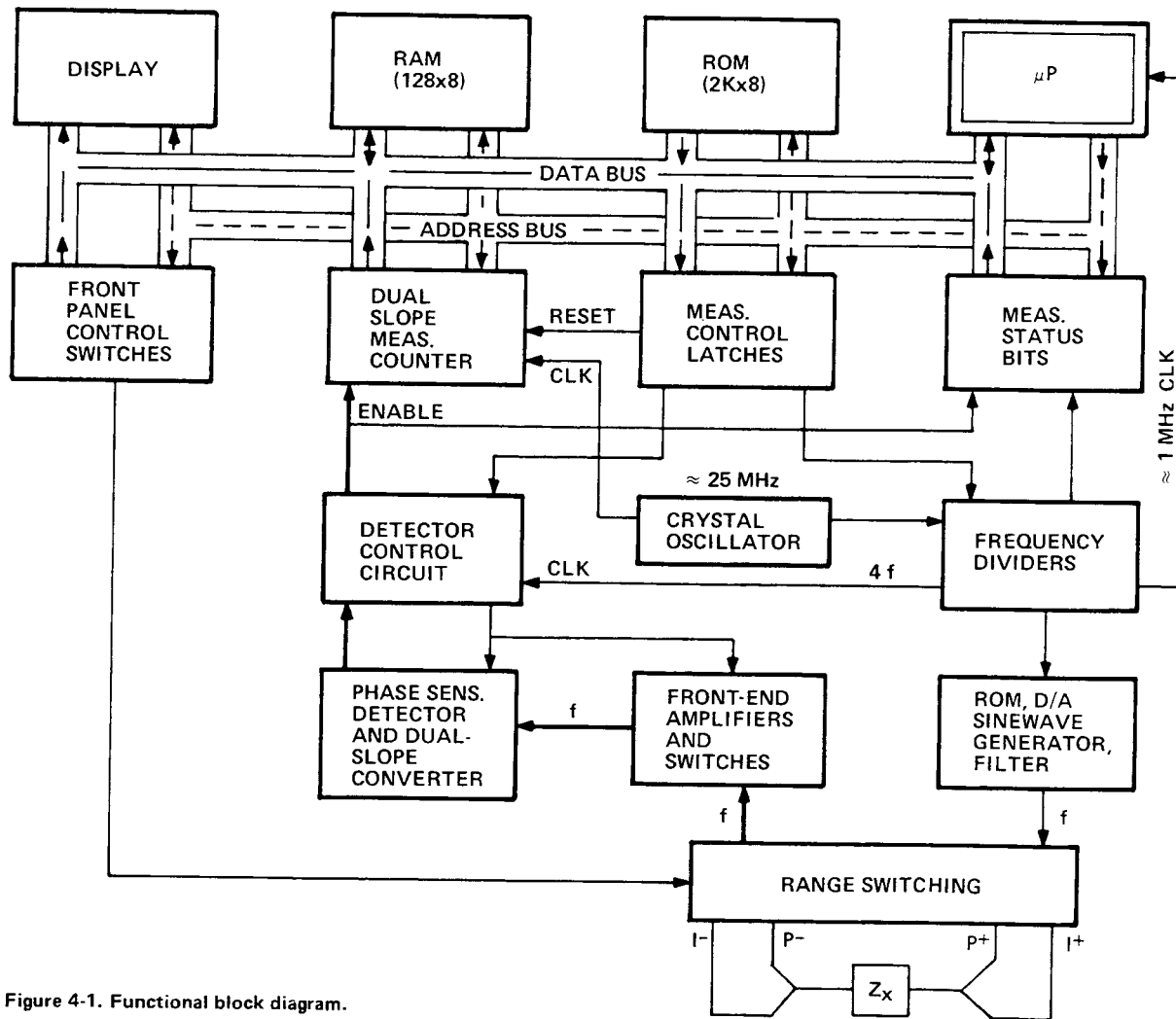

Figure 4-1. Functional block diagram.

The detector control block provides sampling commands (in 4 phases). The detector is a dual-slope converter, including an integrator and comparator, which converts each phase component of the analog signal proportionally into a period of time. The dual-slope measurement is converted into a digital number by a counter that is gated by this period. From this information and manually selected criteria, the microprocessor calculates the RLC and DQ values subsequently displayed.

4.2 PRINCIPAL FUNCTIONS.

4.2.1 Elementary Measurement Circuit. Figure 4-2.

The measurement technique is shown diagrammatically. A sine-wave generator drives current I_x through the DUT Z_x and standard resistor R_s in series. Two differential amplifiers with the same gain K produce voltages e_1 and e_2 . Simple algebra, some of which is shown in the figure, leads to the expression for the "unknown" impedance:

$$Z_x = R_s \frac{e_1}{e_2}$$

Notice that this ratio is complex and that (unless you are measuring resistance) both a magnitude and a loss value are automatically calculated from Z_x and frequency.

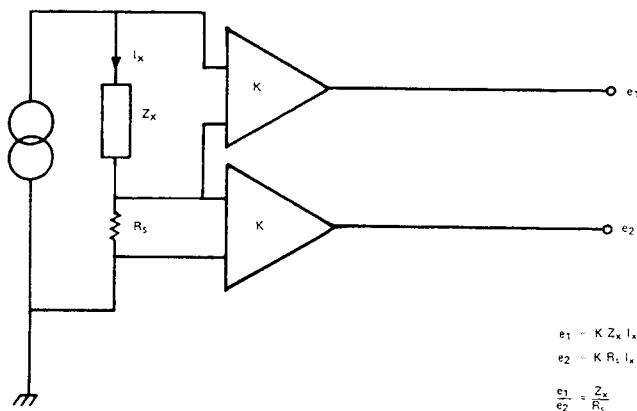

$$\begin{aligned} e_1 &= K Z_x I_x \\ e_2 &= K R_s I_x \\ \frac{e_1}{e_2} &= \frac{Z_x}{R_s} \end{aligned}$$

Figure 4-2. Elementary measurement circuit.

4.2.2 Frequency and Time Source.

Figure 4-3.

A necessary standard for accuracy is the frequency of the test signal; and equally important are the generation of 4-phase references for detection and clocks for the microprocessor. Frequency and timing requirements are implemented by derivation from a single very accurate oscillator, operating near 25 MHz. Digital dividers and logic circuitry provide the many clocks and triggers, as well as driving the sine-wave generator described below.

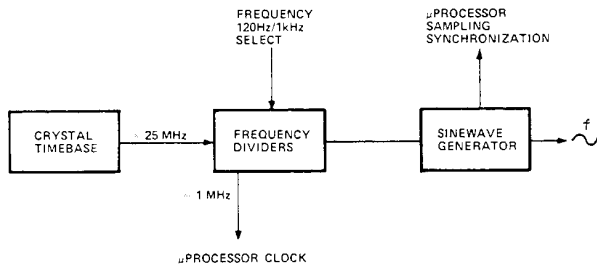

Figure 4-3. Frequency and timing source. A pushbutton determines the frequency select function. Several clocks and synchronizing pulses as well as the measurement signal f are derived from the accurate time-base signal.

4.2.3 Sine-Wave Generation.

Figure 4-4.

Starting with a digital signal at 256 times the selected test frequency, the sinewave generator provides the test signal that drives a small but essential current through the DUT.

Binary dividers count down from 256 F , providing 128 F , 64 F , 32 F ,... 2 F , F . This set of signals is used to address a read-only memory which contains a 256-step approximation to a sine function. The ROM output (as an 8-bit binary number) is converted by a D/A converter to a somewhat "noisy" sine-wave, which is then smoothed by filtering before its use in the measurement of a DUT.

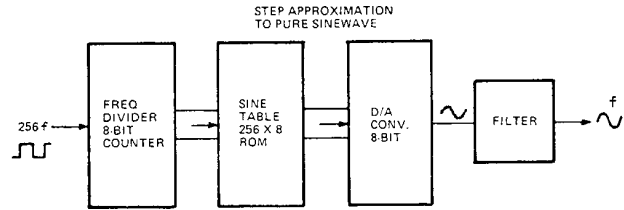

Figure 4-4. Sinewave generator. Given a square wave at $256 f$, from preceding dividers, this generator uses a ROM containing the mathematical sine function to form a finely stepped approximation to a sine wave at frequency f . A filter provides smoothing.

Service and Maintenance – Section 5

5.1 CUSTOMERSERVICE	5-1
5.2 INSTRUMENT RETURN.....	5-1
5.3 REPAIR AND REPLACEMENT OF PLUG-IN BOARDS.....	5-1
5.4 PERFORMANCE VERIFICATION.....	5-2
5.5 MINIMUM-PERFORMANCE STANDARDS.....	5-2
5.6 DISASSEMBLY AND ACCESS.....	5-9
5.7 PERIODIC MAINTENANCE.....	5-11
5.8 TROUBLE ANALYSIS.....	5-13

WARNING

These servicing instructions are for use by qualified personnel only. To avoid electrical shock, do not perform any servicing, other than that contained in the operating instructions, unless you are qualified to do so.

CAUTIONS

For continued protection against fire hazard, replace fuse only with same type and ratings as shown on rear panel and in parts list.

Service personnel, observe the following precautions whenever you handle a circuit board or integrated circuit in this instrument.

HANDLING PRECAUTIONS FOR ELECTRONIC DEVICES

SUBJECT TO DAMAGE BY STATIC ELECTRICITY

Place instrument or system component to be serviced, spare parts in conductive (anti-static) envelopes or carriers, hand tools, etc. on a work surface defined as follows. The work surface, typically a bench top, must be conductive and reliably connected to earth ground through a safety resistance of approximately 250 kilohms to 500 kilohms. Also, for personnel safety, the surface must NOT be metal. (A resistivity of 30 to 300 kilohms per square is suggested.) Avoid placing tools or electrical parts on insulators, such as books, paper, rubber pads, plastic bags, or trays.

Ground the frame of any line-powered equipment, test instruments, lamps, drills, soldering irons, etc., directly to earth ground. Accordingly, (to avoid shorting out the safety resistance) be sure that grounded equipment has rubber feet or other means of insulation from the work surface. The instrument or system component being serviced should be similarly insulated while grounded through the power

cord ground wire, but must be connected to the work surface before, during, and after any disassembly or other procedure in which the line cord is disconnected. (Use a clip lead.)

Exclude any hand tools and other items that can generate a static charge. (Examples of forbidden items are nonconductive plunger-type solder suckers and rolls of electrical tape.)

Ground yourself reliably, through a resistance, to the work surface; use, for example, a conductive strap or cable with a wrist cuff. The cuff must make electrical contact directly with your skin; do NOT wear it over clothing. (Resistance between skin contact and work surface through a commercially available personnel grounding device is typically in the range of 250 kilohms to 1 megohm.)

If any circuit boards or IC packages are to be stored or transported, enclose them in conductive envelopes and/or carriers. Remove the items from such envelopes only with the above precautions; handle IC packages without touching the contact pins.

Avoid circumstances that are likely to produce static charges, such as wearing clothes of synthetic material, sitting on a plastic-covered or rubber-footed stool (particularly while wearing wool), combing your hair, or making extensive erasures. These circumstances are most significant when the air is dry.

When testing static-sensitive devices, be sure dc power is on before, during, and after application of test signals. Be sure all pertinent voltages have been switched off while boards or components are removed or inserted, whether hard-wired or plug-in.

5.1 CUSTOMER SERVICE.

Our warranty (at the front of this manual) attests the quality of materials and workmanship in our products. If malfunction does occur, our service engineers will assist in any way possible. If the difficulty cannot be eliminated by use of the following service instructions, please write or phone the nearest GenRad service facility (see back page), giving full information of the trouble and of steps taken to remedy it. Describe the instrument by name, catalog number, serial number, and 10 (lot) number if any. (Refer to front and rear panels.)

5.2 INSTRUMENT RETURN.

5.2.1 Returned Material Number.

Before returning an instrument to GenRad for service, please ask our nearest office for a "Returned Material" number. Use of this number in correspondence and on a tag tied to the instrument will ensure proper handling and identification. After the initial warranty period, please avoid unnecessary delay by indicating how payment will be made, i.e., send a purchase-order number.

5.2.2 Packaging.

To safeguard your instrument during storage and shipment, please use packaging that is adequate to protect it from damage, i.e., equivalent to the original packaging. Any GenRad field office can advise or provide packing material for this purpose. Contract packaging companies in many cities can provide dependable custom packaging on short notice. Here are two recommended packaging methods.

Rubberized Hair. Cover painted surfaces of instrument with protective wrapping paper. Pack instrument securely in strong protective corrugated container (350 lb/sq in. bursting test), with 2-in. rubberized hair pads placed along

all surfaces of the instrument. Insert fillers between pads and container to ensure a snug fit. Mark the box "Delicate Instrument" and seal with strong tape or metal bands.

Excelsior. Cover painted surfaces of instrument with protective wrapping paper. Pack instrument in strong corrugated container (350 lb/sq in. bursting test), with a layer of excelsior about 6 in. thick packed firmly against all surfaces of the instrument. Mark and seal the box as described above.

5.3 REPAIR AND REPLACEMENT OF CIRCUIT BOARDS.

This instruction manual contains sufficient information to guide an experienced and skillful electronic technician in fault analysis and the repair of some circuits in this instrument. If a malfunction is localized to one board (or more) that is not readily repairable, it can be returned to GenRad for repair. To save time, we recommend that you obtain a replacement first, as described below, before returning the faulty board.

Exchanges. For economical, prompt replacement of any etched-circuit board, order an exchange board. Its price is considerably less than that of a new one. Place the order through your nearest GenRad repair facility. (Refer to the last page of this manual.) Be sure to request an exchange board and supply the following information:

1. Instrument description: name and catalog and serial numbers. Refer to front and rear panels.
2. Part number of board. Refer to the parts lists in this manual. (The number etched in the foil is generally NOT the part number.)
3. Your purchase order number. This number facilitates billing if the unit is out of warranty and serves to identify the shipment.

To prevent damage to the board, return the defective board in the packing supplied with the replacement (or equivalent protection). Please identify the return with the

1. Instrument description: name and catalog and serial numbers. Refer to front and rear panels.
2. Part number of board. Refer to the parts lists in this manual. (The number etched in the foil is generally NOT the part number.)
3. Your purchase order number. This number facilitates billing if the unit is out of warranty and serves to identify the shipment. The repair facility will arrange for the prompt delivery of a replacement.

To prevent damage to the board, return the defective board in the packing supplied with the replacement (or equivalent protection). Please identify the return with the Return Material number on the tag supplied with the replacement and ship to the address indicated on the tag.

New Boards. For equally prompt replacement of any etched-circuit board, and for maximum life expectancy, order a new one. Use the same procedure as described above, but request a new board. Please return the defective one to GenRad.

5.4 PERFORMANCE VERIFICATION.

This procedure is recommended for verification that the instrument is performing normally. *No other check is generally necessary* because this procedure checks operation of nearly all the circuitry. There are no calibrations or adjustments that could require resetting; and the internal standards are very stable. (However, for a rigorous performance and accuracy check, refer to para 5.5.) The necessary resistors, capacitors, and inductors are inexpensive and readily obtained. The most accurate ones available should be used; tolerances listed are the "best" commonly catalogued. Refer to Table 5-1.

CAUTION

Be sure the line voltage switch, rear panel, is correctly set for your power line voltage.

- Verify performance as follows:
- a. Set the line voltage switch, connect the power cord, and depress the POWER button.
 - b. Press the PARALLEL/SERIES button, if necessary, so that the SERIES light stays lit.
 - c. Press FUNCTION button R.
 - d. Press the FREQUENCY button, if necessary, so that the 120 Hz (100 Hz) light stays lit.
 - e. Press the RANGE 1 button.
 - f. Install the test fixture adaptors, as described in para 3.2. Insert the 49.9-0 resistor as the device to be tested or "unknown" component (DUT).

g. Verify that the displays are within the extremes shown in "check number 1" in Table 5-2, if the resistor value is within the tolerance listed above.

h. Similarly make the other checks indicated in this table. In check number 12, verify that the 5th digit is reasonably stable, as follows. (Notice that the 4th digit is the least significant one in the readout, for 0.2% accuracy.)

i. In check number 12, the flickering of the 5th digit should stay typically within a range of +/-3 counts. For example, if the display is 1.101 X,uF, the "X" might flicker between 2 and 8 (or a smaller range). If, for example, "X" is flickering between 7 and 13, it will of course cause a flickering of the preceding digit (1.1017 to 1.1023). In such a case, the correct readout is the larger 4-digit number (1.102) and the 5th digit is acceptably stable.

Tolerances. Acceptable performance of the instrument is bracketed by the set of display "extremes" in Table 5-2. These are defined as the nominal (ideal) measurements plus-or-minus the sum of the instrument accuracy tolerance and twice the DUT accuracy tolerance. If the accuracy of your DUT is different from the recommendation, revise the acceptable "extremes" accordingly. Notice that this performance verification is NOT intended to prove the accuracy of the instrument.

Table 5-1
RESISTORS, CAPACITORS, AND INDUCTORS

Name	Type*	Nominal Value	Tolerance
Resistors, metal film	MIL-R-10509C (style RN60)	49.9 Ω	0.1%
		499 Ω	0.1%
		4.99 kΩ	0.1%
		49.9 kΩ	0.1%
		499 kΩ	0.1%
Capacitors, polystyrene	Arco: 1PJ-332J 1PJ-333J 1PJ-334J 1PJ-504J	0.0033 μF	0.5%
		0.033 μF	0.5%
		0.33 μF	0.5%
		0.5 μF	0.5%
		metalized polyester	GE: BA-14A105C BA-19A106C
10 μF	5%		
Inductors, nonferrous ferrite core	J.W. Miller 9220-28 9250-107	1000 μH	5%
		100 mH	10%

*Equivalents may be substituted.

Table 5-2
PERFORMANCE VERIFICATION

Check Number	Function; Frequency	Range	DUT	RLC Display Extremes**	DQ Display Extremes**
1	R; 120 Hz*	1	49.9 Ω	049.70 to 050.10 Ω	Blank
2		2	499 Ω	0.4970 to 0.5010 kΩ	
3		2	4.99 kΩ	04.970 to 05.010 kΩ	
4		3	49.9 kΩ	.04970 to .05010 MΩ	
5		3	499 kΩ	0.4970 to 0.5010 MΩ	
6	C/D; 1 kHz	3	.0033 μF	03.260 to 03.340 nF	(.0000 to .0100)
7	120 Hz*	3	.0033 μF	03.260 to 03.340 nF	
8	1 kHz	2	.033 μF	.03260 to .03340 μF	
9	120 Hz*	3	.033 μF	032.60 to 033.40 nF	(.0000 to .0100)
10	both freq	2	0.33 μF	0.3260 to 0.3340 μF	
11	both freq	2	0.5 μF	0.4940 to 0.5060 μF	
12	both freq	2	1.0 μF	0.8980 to 1.1020 μF	(.0000 to .0300)
13	1 kHz	1	10 μF	08.980 to 11.020 μF	
14	120 Hz*	2	10 μF	08.980 to 11.020 μF	
15	L/Q; 1 kHz	1	1000 μH	0.8980 to 1.1020 mH	(03.00 to 300.0)
16		2	100 mH	.07980 to .12020 H	(03.00 to 300.0)
17	C/D; 1 kHz	2	Series***	.03260 to .03340 μF	.1030 to .1080***
18	1 kHz	2	Series***	.03260 to .03340 μF	.0094 to .0117***

* 120 or 100 Hz.

** Refer to paragraphs headed "Tolerances" and "Insignificant figures."

*** Refer to paragraph headed "Series DUT." The tabulated D extremes apply to the 1657-9700; for the 1657-9800, in step 17 substitute .1010 to .1059, in step 18 substitute .0092 to .0115.

Insignificant figures. The right-hand digit(s) of the display normally flicker and change if they are not significant for the specified accuracy of the instrument. Refer to para 3.4.

Series DUT. For check number 17 of Table 5.2, the SUT is a series connection of 0.033 uF and 499 for check 18, 0.033 uF and 49.9 . For these checks, remove the adaptors from the test fixture. Insert the resistor in one side and the capacitor in the other side, both slanted so their upper leads cross each other. Clamp them together with a small alligator clip or paper clip.

5.5 MINIMUM PERFORMANCE STANDARDS.

5.5.1 General.

This procedure is a more rigorous alternative to the performance verification described above. Precision stan. dards of impedance are required for this procedure, which checks the accuracy as well as the overall performance of the instrument. It will be controlled from the front panel, without disassembly. Table 5.3 lists the recommended standards and associated equipment.

Verify that the instrument meets performance specifications as follows. Notice that the specifications in the front of this manual supercede any that are tabulated below.

Calibration of Standard. The acceptable RLC readout (min to max range) may have to be modified if your actual Zx or Zx accuracy is different from the value tabulated.

For example, if your 1-k standard is actually 1.005 k , known to +/-0.1 %, then the acceptable readout is 1.005 +/-0.3%, i.e., 1.0020 (min) to 1.0080 (max) k . (Refer to check E of Table 5-4.)

Insignificant Digits. The right-hand digit(s) of the display normally may flicker and change if they are not significant for the specified accuracy of the instrument. Refer to para 3.4.

Cable Capacitance. Because the cable adds capacitance in parallel with the OUT, it is sometimes necessary to obtain a "corrected readout" from the numerical display on the instrument. Do this for all checks involving small capacitance (about 1000 pF or less). The equivalent correction for large inductance (above 30 H at 1 kHz or 3000 H at 120 Hz) is not applicable in the recommended .inductance check procedure. For capacitance measurement, obtain the corrected readout by subtracting the cable capacitance from the visible readout, as described in para 3.7. Because C is large compared to cable capacitance and D is small, the simple calculation (subtraction) is applicable whether the measurement is "parallel" or "series."

CAUTION

Be sure the line voltage switch, rear panel, is correctly set for your power line voltage.

Table 5-3

EQUIPMENT FOR ACCURACY VERIFICATION AND TROUBLE ANALYSIS

Name	Requirements	Recommended Type*	
Extender cable	Adapts test fixture to standards with binding post and banana plugs.	GR 1657-9600	
Resistors	Four-terminal, 1 Ω , .02% 10 Ω , .01%	GR 1440-9601*** GR 1440-9611***	
	Decade, 100 to 11 111 000 Ω , 0.01%	GR 1433-9718 (-Y)	
Capacitors	Three-terminal, 100 pF, 0.003% 1000 pF, 0.003% 1 μ F, 0.02%	GR 1404-9702 (-B) GR 1404-9701 (-A) GR 1409-9725 (-Y)	
	Decade, 3-T, 1 pF to 1 ⁺ μ F, 0.05% \pm 0.05 pF	GR 1413-9700	
	Four-terminal, ratio type, 1 μ F to 10 mF, 0.25% (ratios, 0.02%)	GR 1417-9700	
	Dc Blocking, 500 μ F, 10 V	GE 69F2214G2	
Inductors	Fixed, 2-terminal, 100 μ H, 0.25% 1 mH, 0.1% 10 mH, 0.1% 100 mH, 0.1% 1 H, 0.1% 10 H, 0.1%	GR 1482-9702 (-B) GR 1482-9705 (-E) GR 1482-9708 (-H) GR 1482-9712 (-L) GR 1482-9716 (-P) GR 1482-9720 (-T)	
	Adaptors	Type 874 (for 1413 capacitor) to banana plugs (2 required)	Gilbert Engineering 0874-9870
	Scope**	General purpose, 100 MHz, dual trace	Tektronix 465
	Scope probe**	Capacitance < 10 pF, X10	Tektronix P6053B
	Voltmeter**	Digital, general purpose	Data Precision 2540, with probe
	Counter**	Dc to 35 MHz, 10 mV rms	---
Pulse generator**	General purpose	---	
Resistor**	200 Ω , 1/4 W	---	

* Equivalents may be substituted.

** Required for trouble analysis (paragraph 5.8). Not required for paragraph 5.5.

*** Discontinued. ESI Type SR1 is suitable replacement.

Table 5-4

Check Sequence	Frequency; Function; Parallel/Series	RESISTANCE ACCURACY CHECKS			Instrument Accuracy	RLC Readout** Min to Max
		Range	R _x (exact value)	R _x Accuracy		
A	120 Hz*; R; series	1	1 Ω	.02%	0.4%	00.996 to 01.004 Ω
B	1 kHz; R; series	1	1 Ω	.02%	0.4%	00.996 to 01.004 Ω
C	1 kHz & 120 Hz*	1	10 Ω	.01%	0.2%	09.979 to 10.021 Ω
D	Same (both freq)	1	100 Ω	.01%	0.2%	099.79 to 100.21 Ω
E	Same	2	1 k Ω	.01%	0.2%	0.9979 to 1.0021 k Ω
F	Same	2	10 k Ω	.01%	0.2%	09.979 to 10.021 k Ω
G	Same except parallel	3	100 k Ω	.01%	0.2%	.09979 to .10021 M Ω
H	Same (parallel)	3	1 M Ω	.01%	0.2%	0.9979 to 1.0021 M Ω
I	120 Hz*; R; parallel	3	10 M Ω	.01%	1.0%	9.9990 to 10.101 M Ω

* Either 120 or 100 Hz.

** Tabulated readout is based on tabulated R_x and R_x accuracy. Refer to para 5.1.1.

5.5.2 Resistance Measurement Accuracy.

- a. Set the line voltage switch, connect the power cord, and depress the POWER button. Allow 5 minutes for warm-up (during which time steps b through f can be done) before accuracy determination.
- b. Press the PARALLEL/SERIES button, if necessary, so that the SERIES light stays lit.
- c. Press the FUNCTION button R.
- d. Press the FREQUENCY button, if necessary, so that the 120 Hz (100 Hz) light stays lit.
- e. Press the RANGE 1 button.
- f. Connect the 1- standard resistor to the test fixture, using the extender cable, as described in para 3.1. Connect cable I+ and I- to the posts on the front of the resistor, and P+ and P- to the corresponding plugs on the back. (Leave G of the cable unconnected.)
- g. Verify that the R LC readout is between the min and max extremes tabulated for check A in Table 5-4. (Refer to para 5.5.1 for exceptions.)
- n. Continue through the checks specified in the table. Connect to the decade resistor (checks D, E, etc.) as follows: stack cable tips I+ on P+ and plug them into resistor terminal H; stack I- on P- and plug them into L; connect G to G.

5.5.3 Capacitance Measurement Accuracy.

Continue as in the resistance accuracy procedure, above, except as follows:

- a. Follow Table 5-5 for details of setup and performance.
- b. Refer to para 3.7, for details of connection to 3-terminal capacitors with coaxial connectors and for the

determination of cable capacitance. The corrected readout of capacitance is the actual display minus the cable capacitance.

CAUTION

Do NOT connect the 1417 capacitor without a dc blocking capacitor in series with the connection between the CURRENT H terminal and the Digibridge (I+ terminal).

- c. For C standards greater than 1 uF (checks R, S, T..), using the GR 1417 Four-Terminal C Standard, connect a 500-J1F dc blocking capacitor between the CURRENT H terminal and the I+ tip of the extender cable from the Digibridge. (Orient the blocking capacitor: + to the cable.)
- d. For C standards greater than 1 uF, Cx accuracy better than that indicated in the table can be realized by a calibration of the 1-uF value and proportional correction of the higher values of the GR 1417. Typical accuracy is 0.06% if the GR 1413 is used as the standard. (Refer to the 1417 instruction manual for details.) However, for a Cx accuracy of about 0.25%, no calibration is required.

5.5.4 D Measurement Accuracy.

Continue with the accuracy procedure as follows:

- a. For DUT, make a series connection of the Rand C decade boxes, by connection from the high (H) terminal of the resistance box to the inner low (L) terminal of the capacitance box. Stack cable tips I+ and P+ and connect these to the inner high (H) terminal of the capacitance box. Similarly stack I- and P- on low (L) of the resistance

Table 5-5

CAPACITANCE ACCURACY CHECKS						
Check Sequence	Frequency; Function; Parallel/Series	Range	C _x Actual	Typical C _x Accuracy	Instrument Accuracy	Corrected RLC Readout Min to Max**
J	1 kHz; C/D; series	3	100 pF	.003%	0.4%	0.0996 to 0.1004 nF
K	1 kHz	3	1000 pF	.003%	0.2%	0.9980 to 1.0020 nF
L	120 Hz*	3	1000 pF	.003%	0.4%	0.9960 to 1.0040 nF
M	1 kHz and 120 Hz*	3	0.01 μF	.05%	0.2%	0.9975 to 1.0025 nF
N	120 Hz*	3	0.1 μF	.05%	0.2%	0.9975 to 1.0025 nF
O	1 kHz	2	0.1 μF	.05%	0.2%	.09975 to .10025 μF
P	1 kHz	2	1 μF	0.02%	0.2%	0.9978 to 1.0022 μF
Q	120 Hz*	2	1 μF	0.03%	0.2%	0.9977 to 1.0023 μF
R	120 Hz*	2	10 μF	0.25%**	0.2%	0.9955 to 1.0045 μF
S	1 kHz	1	10 μF	0.25%	0.2%	0.9955 to 1.0045 μF
T	1 kHz	1	100 μF	0.25%	0.2%	0.9955 to 1.0045 μF
U	120 Hz*	1	100 μF	0.25%	0.2%	0.9955 to 1.0045 μF
V	120 Hz*	1	1 mF	0.25%	0.2%	0.9955 to 1.0045 μF
W	120 Hz*	1	10 mF	0.25%	1%	9875.0 to 10125 μF

*Either 120 or 100 Hz.
 **Correct actual display for cable capacitance. Slightly different min and max obtain if C_x and C_x accuracy are different from tabulated values. Refer to para 5.5.1. In particular, steps R . . . W can be made more exacting, with acceptable values of C readout that depend on C_x calibration, as explained in the text.

box. (Be sure this is not strapped to G.) Connect cable tip G to G of the resistance box and to the outer terminals of the capacitance box.

b. Follow checks AA... AF in Table 5-6. Notice that the capacitor settings depend on catalog number of the instrument as well as front-panel frequency settings. Refer to the footnotes in the table.

c. Change the DUT to a parallel combination of Rand C decade boxes, by changing the high (H) connection of the R box from inner low to inner high (H) connection of the C box and by connecting low (L) of the R box to the inner low (L) of the C box.

d. Perform checks BA ...BF (as in step b above), with C box set to C3 and frequency of 1 kHz (nominal).

e. Change C box setting to C4 and frequency to 120 Hz (100 Hz). Repeat checks BA. ..BF.

5.5.5 Inductance Measurement Accuracy.

Continue as in the resistance and capacitance accuracy procedures except as follows.

a. Follow Table 5-7 for details of setup and performance.

b. For check "CA", the GR 1482-B inductor must be measured twice, i.e., once with a shorting link from center to left "reference" terminals, once with the link from center to right. (Connect the extender cable to the "connection terminals, NOT the reference" terminals.)

The difference between these 2 measurements is the corrected readout. For each other check, CB, CC, CD ..., a single measurement is sufficient. Refer to "Method of Measurement" on the calibration certificate of the inductor.

c. Notice that the low-frequency checks are somewhat limited by the low Q's of the standard inductors. A Q of 1 or less causes a factor of 2 or more degradation in the specified accuracy of inductance measurement.

5.6 DISASSEMBLY AND ACCESS.

WARNING

If disassembly or servicing is necessary, it should be performed only by qualified personnel familiar with the electrical shock hazards inherent to the high-voltage circuits inside the cabinet.

CAUTION

Observe the following precautions whenever you handle a circuit board or integrated circuit in this instrument.

(Refer to page 5-0.)

Table 5-6
DISSIPATION-FACTOR ACCURACY CHECKS

Check Sequence	Frequency; Function; Parallel/series	Range	R; C	Nominal D	Typical D Accuracy	Instrument Accuracy	DQ Readout Min to Max
Z	1 kHz; C/D; series	2	100 Ω; C ₁ *	.0096	.07%	10.6%	.0086 to .0106
AA	Same	2	100 Ω; C ₂ *	0.0192	.07%	5.4%	.0182 to .0203
AB	Same	2	300 Ω; C ₂	0.0577	.07%	1.95%	.0565 to .0588
AC	Same	2	1 kΩ; C ₂	0.1923	.07%	0.76%	.1907 to .1939
AD	Same	2	3 kΩ; C ₂	0.5768	.07%	0.49%	.5736 to .5800
AE	Same	2	10 kΩ; C ₂	1.923	.07%	0.64%	1.909 to 1.936
AF	Same	2	30 kΩ; C ₂	5.768	.07%	1.37%	5.685 to 5.851
BA	C/D; parallel	2	50 kΩ; C ₃ **	.05	.07%	2.21%	.0489 to .0511
BB	Same	2	25 kΩ; C ₃	0.1	.07%	1.22%	.0987 to .1013
BC	Same	2	5 kΩ; C ₃	0.5	.07%	0.50%	.4971 to .5029
BD	Same	2	2.5 kΩ; C ₃	1.0	.07%	0.50%	.9943 to 1.006
BE	Same	2	500 Ω; C ₃	5.0	.07%	1.22%	4.935 to 5.065
BF	Same	2	277.7 Ω; C ₃	9.0	.07%	2.01%	8.813 to 9.187

*For 1657-9700 (f = 1020 Hz), C₁ = .0150 and C₂ = .0300 μF.

For 1657-9800 (f = 1000 Hz), C₁ = .0153 and C₂ = .0306 μF.

**For 1657-9700 (f = 1020 Hz), C₃ = .062414 μF.

For 1657-9700 (f = 120 Hz), C₄ = 0.53052 μF.

For 1657-9800 (f = 1000 Hz), C₃ = .063662 μF.

For 1657-9800 (f = 100 Hz), C₄ = 0.63662 μF.

Table 5-7

Check Sequence	Frequency; Function; Parallel/Series	INDUCTANCE ACCURACY CHECKS				
		Range	Effective L_s	Expected Q	Accuracy of L_s ; Instrument	RLC Readout* Min to Max
CA	1 kHz; L/Q; series	1	100 μ H	7.6	0.12; 0.45%	0.0994 to 0.1006 mH
CB	1 kHz	1	1 mH	7.5	.03; 0.23%	0.9974 to 1.0026 mH
CC or	120 Hz 100 Hz	1	1 mH	0.90 0.75	.03; 0.84% .03; 0.93%	0.9913 to 1.0087 mH 0.9904 to 1.0096
CD or	120 Hz 100 Hz	1	10 mH	0.92 0.77	.02; 0.42% .02; 0.46%	09.956 to 10.044 mH 09.952 to 10.048
CE	1 kHz	1	10 mH	7.7	.02; 0.23%	09.975 to 10.025 mH
CF or	120 Hz 100 Hz	1	100 mH	0.94 0.78	.02; 0.41% .02; 0.46%	099.57 to 100.43 mH 099.52 to 100.48
CG	1 kHz	2	100 mH	7.7	.02; 0.23%	.09975 to .10025 H
CH	1 kHz	2	1 H	10.	.02; 0.22%	0.9976 to 1.0024 H
CI or	120 Hz 100 Hz	2	1 H	1.2 1.0	.02; 0.37% .02; 0.40%	0.9961 to 1.0039 H 0.9958 to 1.0042
CJ or	120 Hz 100 Hz	2	10 H	1.18 0.98	.02; 0.37% .02; 0.40%	09.961 to 10.039 H 09.958 to 10.042
CK	1 kHz	3	10 H	9.8	.02; 0.22%	09.976 to 10.024 H

* Tabulated readout is based on tabulated L_s and L_s accuracy. Refer to para 5.5.1.

5.6.1 Disassembly.

Figures 5-1 through 5-6.

Use the following procedure for access to replaceable parts and contact points used in trouble analysis.

- a. Disconnect the power cord.
- b. Remove the top-cover screws from the rear panel of the main chassis. See Figure 1-2. Slide the top cover forward about 6 mm, so that its front corners are unhooked. Lift it directly upward (Figure 5-1). Reassembly note: 2 screws, 13 mm long.

The next step, removal of display board, is recommended (though not absolutely necessary) before removal of the main circuit board.

- c. Remove the 2 support screws, at left and right, that hold the display board to its brackets. (See Figure 5-8 in para 5.6.2.) Pull the board directly out of its socket in the main board. Keep the display board in its original (inclined) plane until it is completely free (Figure 5-2).

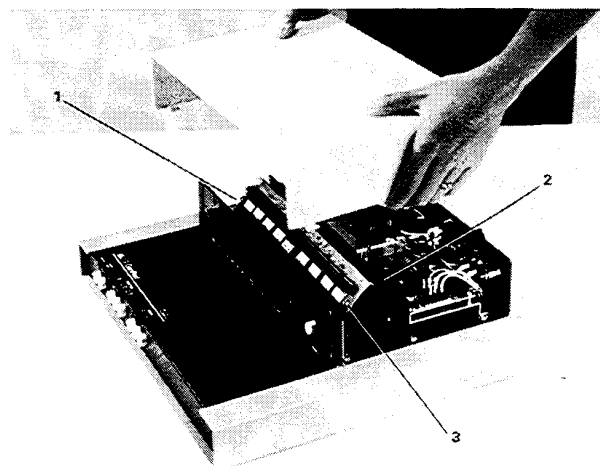

Figure 5-1. Removal of top cover. Items 1 and 3 are screws that hold the display board. Item 2 is ribbon cable 1657-0200 that connects power supply to C board.

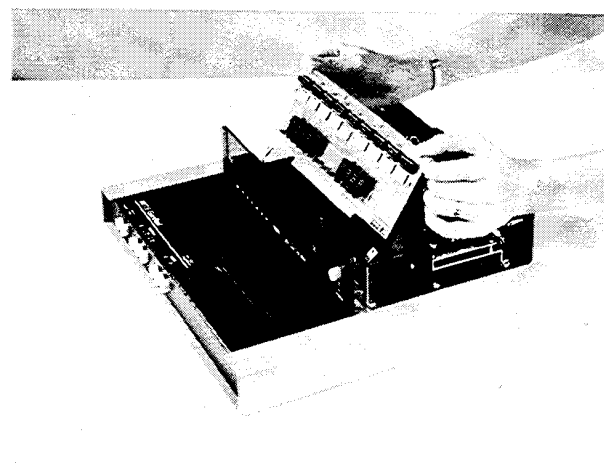

Figure 5-2. Removal of the display board. Note: The personnel grounding strap that is required is not shown in this and other disassembly views. (The model was wearing it above the elbow.)

d. Remove the ribbon cable (1657-0200) from power supply (at V-J1) and main board (at C-J1). Notice that the connectors are symmetrical and reversible; and the cable is extra long, for convenience in servicing.

The next step, removal of the power supply, is NOT related to the removal of the main board. Either can be left in place while the other is removed.

e. Remove the 4 screws that pass vertically through the corners of the power supply into the main chassis. Lift the power supply slightly and move it back carefully while disengaging the POWER pushbutton extension from its hole in the front panel (Figure 5-3). Reassembly note: 4 screws, 8 mm long.

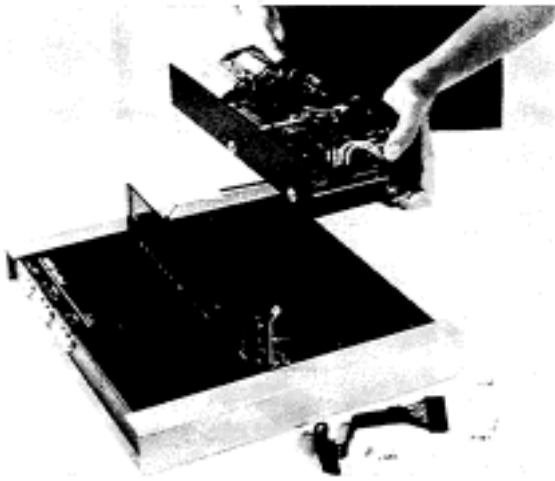

Figure 5-3. Removal of the power supply. The ribbon cable must be disconnected first. The display board can be left in place, but has been removed in this picture.

f. After disconnecting the ribbon cable, provide a convenient "upside-down" support by reinstalling the top cover, temporarily. Turn the instrument, bottom up.

g. Remove 4 screws from the bottom shell, one near each rubber foot. Slide the bottom shell back (or forward), free of the main chassis (Figure 5-4). Reassembly notes: Be sure to enfold the pliable dirt seals at left and right sides of main chassis as you start to slide bottom shell onto main chassis; use 4 screws, 8 mm long.

h. Remove 8 screws shown in Figure 5-5 as ABCGHI (7 mm) and EJ (8 mm). Lift the rear edge of the main board as shown in Figure 5-6 and slide it back until clear of the main chassis.

i. For access to the test-fixture contacts, which are on the main board, remove screws K L and drop the test-fixture guide block off of the test fixture contacts. Refer to bottom interior view, Figure 5-5.

Notice that it is possible to remove the main board with the display board mounted on it, by this procedure: release all 8 front push buttons; remove screws ABCEGHJI; lift

rear edge of main board 25 mm and slide it forward 16 mm; lift rear edge to 75 mm (so display board clears cutout in main chassis) and slide the assembly back until display board reaches spacer; lift rear edge another 15 mm and slide it back until push buttons are free; lift assembly out.

Reassembly note: install screw "I," loosely. Position test fixture as desired (preferably symmetrical in its opening), before installing screws A, E, etc.

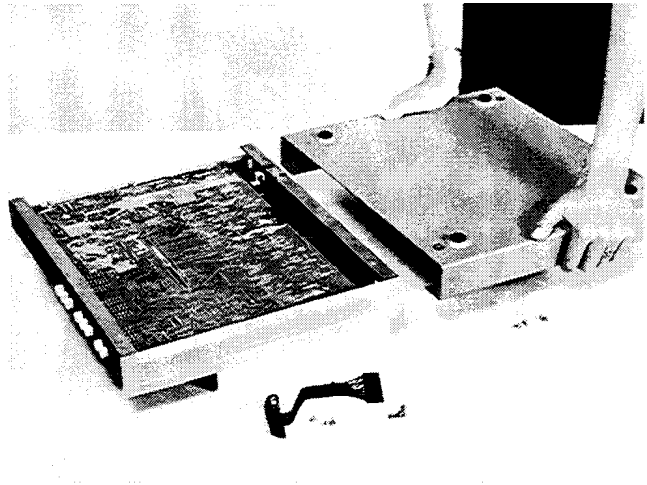

Figure 5-4. Removal of the bottom shell. The top cover has been temporarily installed as a support.

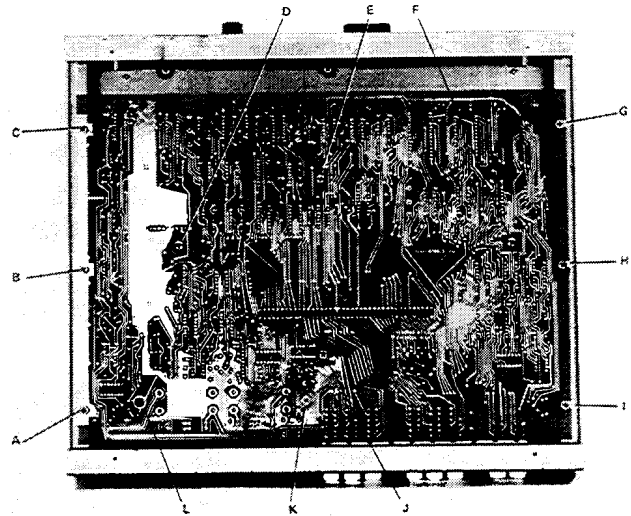

Figure 5-5. Bottom interior view. Screws ABCEGHIJ hold the C board to the chassis. Screws DF hold display-board brackets. Screws KL hold the test-fixture guide block.

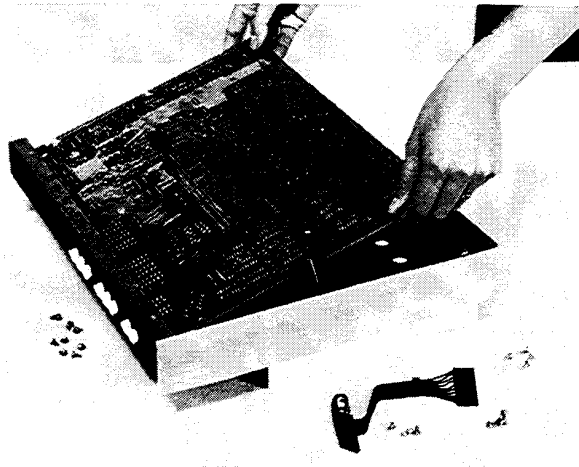

Figure 5-6. Removal of the C board. The ribbon cable must be disconnected first. Prior removal of the display board also is highly recommended.

Screw K must contact etched-circuit ground. A washer is supplied (under screw head) if necessary to do so.

5.6.2 Access.

Figures 5-7 and 5-8.

Interior locations that are important for trouble analysis are shown. Notice the clues to pin numbering; square pads on etched board are generally pin 1. Conversion items are shown, to make a 1657-9700 function as a 1657-9800, or vice versa. (See para 3.1 for line-frequency consideration.) Conversion involves relocating 2 jumpers and substitution of precision oscillator U7; refer to parts list, Section 6. (Thus, with a spare oscillator, one can obtain test frequencies of 100, 120, 1000 Hz.) Notice: if your instrument has separate crystal Y1, it is changed instead of U7; inquire.

The 2 arrows with letters "A" show approximate area (front right corner) of analog circuitry. The rest is digital.

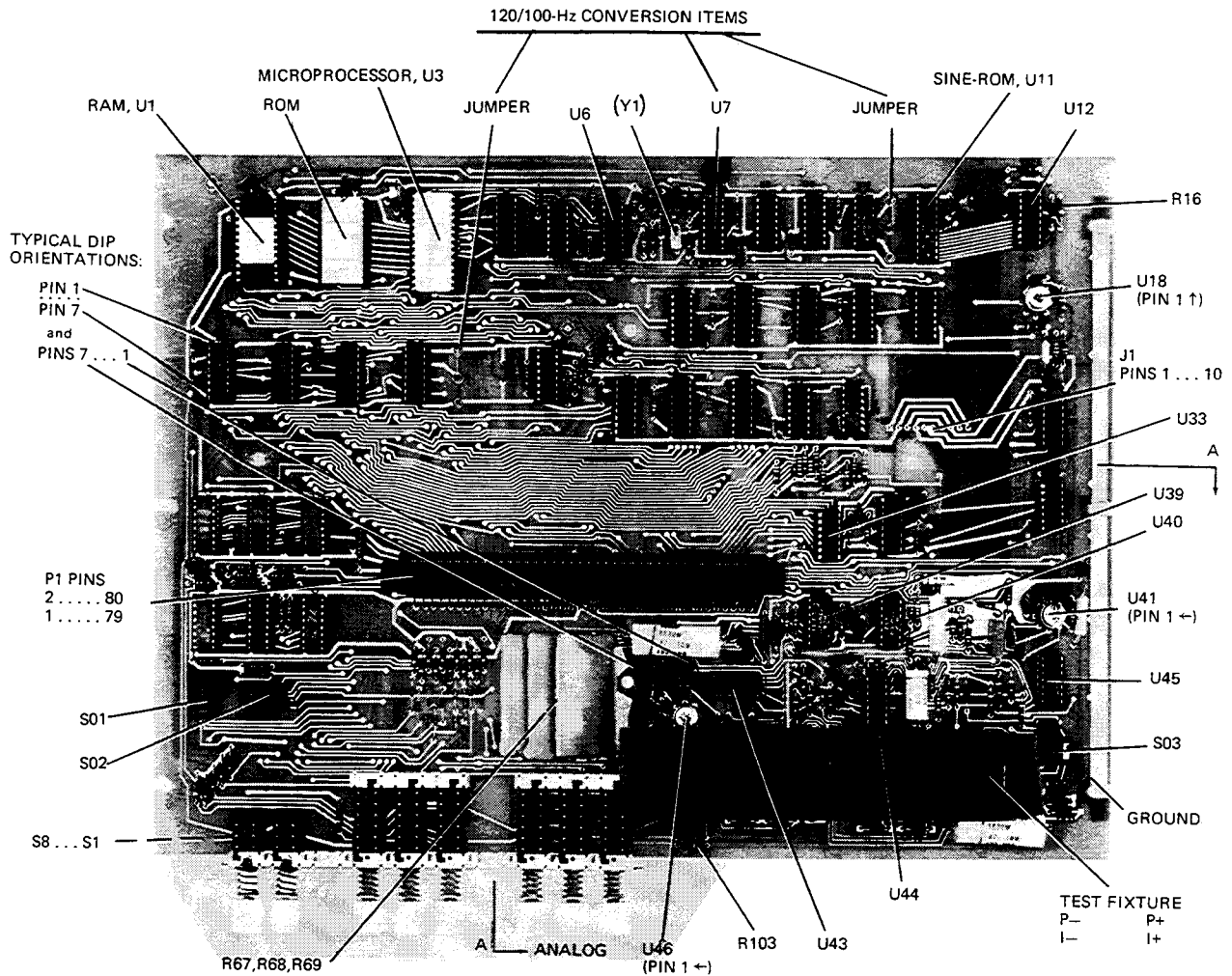

Figure 5-7. Main or C board, top view. Functional conversion between 1657-9700 and 1657-9800 involves replacement of precision oscillator (or crystal Y1, if separate) and relocation of 2 jumpers; locations indicated. Notice that DIP sockets are oriented consistently, for convenience in circuit probing. Arrows A---A indicate approximately the area of analog circuitry.

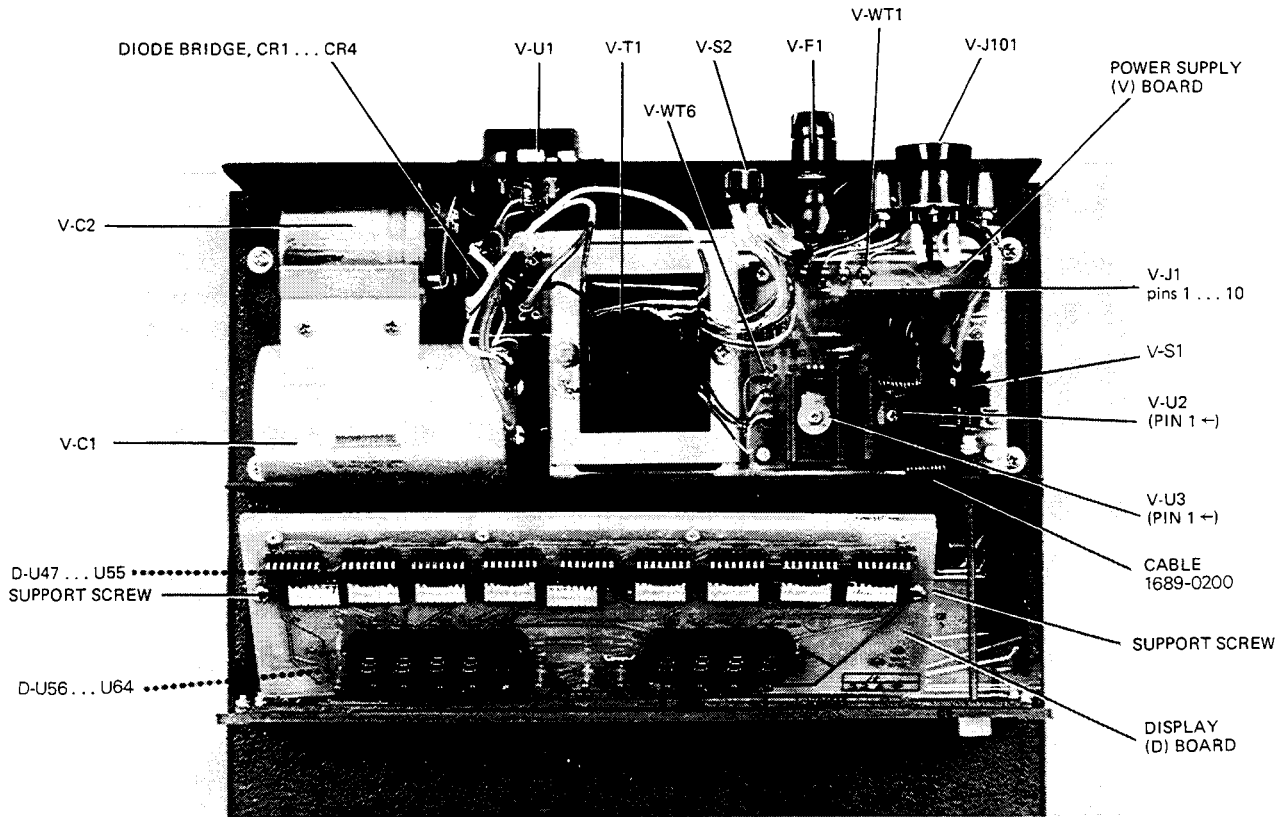

Figure 5-8. Power supply (V assembly) and display or D board, shown in the instrument, with top cover off.

5.6.3 Reference Designations.

Refer to Section 6 for an explanation of these designations. For example, V- T1 designates transformer number one in the power supply (V) assembly. C-U3 is integrated circuit number 3 on the C board, which is the analog and control board or the main board.

5.6.4 Removal of Multiple-Pin Packages.

Use caution when removing a plug-in integrated-circuit or other multiple-pin part, not to bend pins nor stress the circuit board. Withdraw the part straight away from the board. Unless an IC is known NOT to be a MaS type, place it immediately on a conductive pad (pins in the pad) or into a conductive envelope.

Do NOT attempt to remove a soldered-in IC package without the proper equipment and skills to do so without damage. If in doubt, return the board to Gen Rad.

5.7 PERIODIC MAINTENANCE.

5.7.1 Care of the Test Fixture.

About once a year (more or less depending on usage) the test fixture should be inspected and cleaned as follows:

a. Remove the C board and expose the test-fixture contacts by removing its guide block (part number 1657-2200), as described above. See Figure 5-5, screws KL.

b. Clean and check the 4 contact strips. Use a card wet with isopropyl alcohol for cleaning. Hold the board at an angle so that any drip falls away from the circuits.

c. If necessary, the contact strips (part number 16861940) can be removed (2 screws apiece). They are supposed to press against each other, with tiny dielectric spacers preventing contact. Except at the ends of the gap (where the spacers are) the gap should be .05 to 0.2 mm (.002 to .008 in.) all along the gap. If accurate feeler gages are not available, the following criterion can be used: the gap should be large enough to pass a strip of ordinary typing paper without dragging, but narrow enough everywhere (at center and near each end) to cause some drag as a stack of 3 strips of paper is passed through.

For best results and minimum maintenance effort, the operator must remove any obvious dirt from leads of DUT's before inserting them into the test fixture. Its contacts will wipe through a film of wax, but they can become clogged and ineffectual if the operator is careless about cleanliness.

5.7.2 Care of the Display Panel.

Use caution when cleaning the display window, not to scratch it nor to get cleaning substances into the instrument. Use soft cloth or a ball of absorbent cotton, moistened with

a mild glass cleaner, such as "Windex" (Drackett Products Co., Cincinnati, Ohio). Do NOT use a paper towel; do NOT use enough liquid to drip or run.

If it should be necessary to place marks on the window, use paper-based masking tape (NOT any kind of marking pen, which could be abrasive or react chemically with the plastic). To minimize retention of any gummy residue, remove the tape within a few weeks.

5.8 TROUBLE ANALYSIS.

5.8.1 General.

CAUTION

Only well qualified personnel should attempt trouble analysis. Be sure power is OFF during disassembly and setting up for tests. Carefully observe the MOS HANDLING PRECAUTIONS given in para 5.6.

Resources. Refer to Section 4 for a good understanding of the theory of operation. The block diagrams and discussion there provide necessary background, which can generally save time in trouble analysis. Refer to Section 6 for hardware details: circuit layouts, schematic diagrams, and parts lists.

Abnormal digital signal levels. Most digital signal levels in this instrument are normally near zero (logic low), about +3.5 to +5 V (logic high), or rapidly switching between these states. Failure of a digital source often produces a dc voltage of about +2 V on a signal line. Use high-impedance probes in measuring. Use a scope as well as a voltmeter, because an average of 2 V may be normal for a digital signal that has a duty cycle near 50%.

Duplicated circuits. Some circuits, as in the display board for example, are duplicated several times. The IC's can usually be exchanged between a faulty circuit and a functional one, to identify a "bad" IC. Notice, also, that the resistor networks D-Z2 ...D-Z10 are simply compact packages of 220- resistors. If one resistor is open, it is not necessary to replace the entire package. Use a 5% resistor.

Circuit board replacement Refer to para 5.3 for recommended procedures to obtain replacements.

Telltale symptoms. Scan the following group of symptoms for a preliminary analysis of trouble and suggestions for more detailed procedures if applicable.

Display. A perpetually blank digit or decimal point may be caused by a fault in the directly associated circuit on the display board. (Refer to comments above.)

Pushbutton. Malfunction of any pushbutton may be caused by a fault in the switch or in buffer C-U 1 9.

Range. If one range is nonfunctional, check the corresponding switch (C-S1 ...S3), source resistor (R 102. ..), and standard resistor (R69. ..). If range-1 measurements are inaccurate, also check the inverting amplifier in the I- circuit, C-U46 pin 6.

D Error. A large D error on range 3 may be caused by faulty "protection" diodes in the analog front end. Check C-CR12.. .23 (a total of 12 diodes).

D Error. If D measurements are accurate at 1 kHz but erroneous at 120 (100) Hz, fault may be in the test signal filter. Check that C-Q2 is on for low frequency, off for 1 kHz. If so, check the test signal. (See below.)

Reactance Error. If R measurements are accurate but C (and L) measurements are not, the test signal source may be at fault. In checking it, as in the following paragraph, verify that the frequency is within +/-0.01% of the specified "actual" frequency. (See front of manual.)

Test Signal. To check performance of the test-signal source, use a scope to look at the open-circuit signal at the I+ terminal of the test fixture. This should be an undistorted sine wave at the selected frequency, amplitude about 0.6 V pk-pk (+/-15%) on each range. If this is correct, skip over para 5.8.3.

Analog Front End. To check the entire analog front end, verify that the signal at C-U44 pin 8 has the characteristics shown in para 5.8.4, step g, while the instrument is measuring a DUT. If this is true for all modes (FREQUENCY, PAR SERIES, R-L/Q-C/D, RANGES), skip to para 5.8.6. Otherwise, check the test signal at the test fixture as outlined above.

Introduction to Detailed Analysis. The following trouble analysis procedures will serve as a guide for localizing a fault to a circuit area. In some cases, a specific component part can be isolated for replacement. In other cases, the problem can be narrowed down only to a circuit board.

Except for the short-cuts indicated above, follow the procedure strictly in the order given, doing the principal steps (a, b, c, d, ..) until a failure is found. Only then is there any need for the secondary steps, if any are given at the point of failure (aa, ab, ac ...).

5.8.2 Power Supply.

Check the power supply (V assembly) if there is a massive failure (nothing works) or as a starting procedure in any thorough analysis. Refer to figures 5-8 and 6-10.

NOTE

If a power transistor (U1, U2, or U3) must be replaced, be sure to spread silicone grease (like Dow Corning compound no. 5) on the surface toward the heat sink. For U 1, coat both sides of the insulating washer.

a. Check the output voltages, using a digital voltmeter, with ground reference at V-J1, pin 9 (ribbon cable unplugged), as follows:

Pin1=+5V.

Pin3=+5V.

Pin4=-8V.

b. Make a check similar to step a, with ribbon cable connected, ground reference at right edge of C board, probing C-J1 from below the board. (This checks for overload outside the power supply.)

5.8.3 Sinewave Generator.

Figure 6-5.

Check the C-board circuits that supply the test signal to the DUT, as follows: (We proceed backward, toward the sinewave generator.)

a. Make the following test setup and pushbutton selections:

DUT: 0.1 uF and 3 k Ω , connected in series.

FREQUENCY: 1 kHz.

PAR SERIES: SERIES.

FUNCTION: C/D.

RANGE: 2.

b. Verify that the signal at test fixture I+ (Figure 6-4) is a 1-kHz sine wave, 0.6 V pk-pk. Use an oscilloscope.

c. Verify that this signal changes amplitude as you switch ranges, thus:

RANGE 1, 0.68 V pk-pk;

RANGE 3, 20 mV pk-pk.

d. If no fault appears in steps a, b, c, skip to para 5.8.4.

e. Verify that "0.25 V RMS TEST SIGNAL" found at S03 pin 14 is a 1-kHz sine wave, approx 0.6 V pk-pk. (+/-15%). This is the output from U41 pin 6.

f. Check at U41 pin 3 (the pin closest to the front) for a 1-kHz sine wave, 0.4 V pk-pk.

g. Verify that the output of U 18 found at S03 pin 5 is a 1-kHz sine wave, 0.8 V pk-pk. (It is rather noisy, as sketched on the schematic diagram, Figure 6-5.)

h. Remove U 18. Connect a 200- Ω resistor across its socket (XU18) between pins 2 and 3. (Note: if the resistor leads are about 0.5 mm [0.02 in.] in diameter,

aa. If trouble is found at step a, check "+5 V" circuit: At outputs of U1 and U2: +5 V dc (regulated).

At WT1 (inputs of U1 and U2): +10.8 V dc.

Across input to diode bridge (yellow-to-yellow): 10 V rms.

ab. Check "-8 V" circuit:

At output of U3: -8 V dc (regulated).

At input (center terminal) of U3: -13.8 V dc.

Across WT7 to WT8: 11.3 V rms.

ac. Check power-line circuit to primary of transformer V-T1.

ca. If this signal is distorted or missing on all ranges, but present at the right end of R 103, check diode network C-CR 16 ...CR23. If missing on some ranges(s), check source resistor circuit R101... R103 and switches S1... S3.

fa. Check at U45 pin 10 for a 1-kHz sine wave, 60 m V pk-pk. If this is verified but step e is not, fault is in U41.

they will fit the socket directly.) Check at U12 pin 4 for a 1-kHz noisy sine wave, 0.4 V pk-pk. If this is verified but step g is not, fault is in U18. If neither is verified, reinstall U 18 and continue.

i. Check that each input to the D/A converter U12 (pins 5...12), is a digital signal, about 4 V pk-pk. Each of these 8 signals should repeat with a period of 1 ms.

If these digital signals are NOT correct, continue the analysis by checking the crystal oscillator and divider chain, as follows.

NOTE

Dual specifications of frequency appear below.

The first frequency is correct for 1657-9700

(the 120-Hz version). The second is correct

for 1657-9800 (the 100-Hz version). Frequency tolerance is +/-0.01%

j. Make the following test setup. Connect from the scope vertical-channel output to a counter. Be sure to use a lowcapacitance probe at the scope input, so as not to load the high-impedance circuits being analyzed.

k. Oscillator. Check at U8 pin 14 for a fast digital waveform (see schematic diagram) of the following frequency: 25.067 or 24.576 :1:0.003 MHz. If correct,

skip to step 1. (This circuit is easily loaded down by test equipment. A more "tolerant" point is checked in step I.)

l. Check at U8 pin 8 for a square wave, 4 V pk-pk, 2.0889 or 2.0480 MHz. Otherwise, U8 is faulty.

m. Check at U9, pins 1, 9, 8 for pulses (essentially rectangular, as shown on the schematic diagram), with frequencies as follows:

Pin 1, 1.0445 or 1.0240 MHz.

Pin 9, 522.24 or 512.00 kHz.

Pin 8, 261.12 or 256.00 kHz.

Otherwise, U9 is faulty.

n. Check at U10, pins 12,9,5 for similar pulses, as shown, with frequencies as follows:

Pin 12, 276. or 261.12 kHz.

Pin 9, 61.440 or 78.3 kHz.

Pin 5, 30.720 or 26.112 kHz.

Otherwise, U10 is faulty.

NOTE

At pin 12, for the 1657-9700, every 9th square wave is half the regular width; at pin 9, for the 1657-9800, every 3rd positive pulse is only about 1 us wide; therefore the counter reading may vary somewhat, depending on the length of its counting interval.

o. Check at U14 pin 2 for square waves, 5 V pk-pk, at 261.12 or 256.00 kHz.

ia. *If these inputs are verified but step h is not, fault is in U12 circuit. Check at the end of R 16 closest to the rear corner for +3 V dc; if that is correct, replace U 12. Otherwise, fault is in associated circuit*

ka. *If oscillator signal is not verified, remove U8 from its socket and repeat step k. (Check at U13 pin 13, if convenient.) If signal is now normal, U8 is faulty. Otherwise, install U8 and determine whether your instrument has a self-contained oscillator or a separate crystal Y1.*

kb. *If your instrument has a separate crystal, remove it and repeat step k. The correct frequency is approx 31.2 MHz (either 120- or 100-Hz version). If this is verified, Y1 is faulty. Otherwise, install Y1 and check at U7 pins 2, 3, 11 for voltages of +4, +3, +4.2V, respectively. If they are correct, U7 is faulty.*

kc. *If your instrument has the self-contained oscillator, failure in steps k and ka indicates the oscillator U7 is faulty.*

oa. *If step 0 is not confirmed, be sure you have selected 1 kHz on the front panel. Check that FREO SEL (U15 pin 8) is logic high and FREO SEL (pin 6) is low. (Otherwise check back through U24, U19, and S8.)*

ob. *If those checks are confirmed, fault is in the gates U15 pins 4, 10,3 or U14 pin 2.*

p. While monitoring U14 pin 2, push the FREQUENCY pushbutton and select 120 Hz, (or 100 Hz). Check that the monitored signal (which should always be 256 times the test frequency) is now 30720 Hz or 25600 Hz. Again push the FREQUENCY button to select "1 kHz."

q. Check that the outputs of U 16 are square waves, 5 V pk-pk, frequencies as follows (for 1657-9700 or 1657-9800 respectively):

Pin 12, 130.56 or 128.00 kHz.

Pin 9, 65.28 or 64.00 kHz.

Pin 8, 32.64 or 32.00 kHz.

Pin 11, 16.320 or 16.00 kHz.

Otherwise, U 16 is faulty.

r. Check U17 similarly:

Pin 12, 8.160 or 8.000 kHz.

Pin 9, 4.080 or 4.000 kHz.

Pin 8, 2.040 or 2.000 kHz.

Pin 11, 1.0200 or 1.0000 kHz.

Otherwise U17 is faulty.

s. If inputs to the sine rom U 11 are valid (steps j ...r) but its output is not (steps a.. .i), U11 is faulty; or possibly (because step i does not check the output code from U 11) U 12 may be faulty. They can be checked against their manufacturer's data sheets.

5.8.4 Front End Amplifiers and Switches.

Figure 6-3.

Check the C-board analog circuits that process the measurement signals from the test fixture to the point of A/D conversion, as follows:

- a. Verify that there is a normal test signal at the test fixture. (See para 5.8.1 or para 5.8.3 step b.)
- b. Make the setup of para 5.8.3, step a. Measure using a low-capacitance probe with an oscilloscope. (The frequency counter is not needed.)
- c. Check at U43 pin 1 for 1-kHz sine wave, 500 to 620 mV pk-pk. Check at U43 pin 8 for a similar waveform, 150 mV pk-pk.
- d. Check at switch U39 pin 3, using the gate signal SSW1 (U39 pin 5) as a trigger for your scope. Pin 3 should be a 1-kHz switched sine wave, 500 to 620 mV pk-pk for a few cycles, while SSW1 is logic high.
- e. Similarly, check at switch U39 pin 10, using the gate signal SSW2 (U39 pin 12) as trigger. The signal at pin 10 should be a switched 1-kHz sine wave, 150 to 190 mV pk-pk for a few cycles, while SSW2 is logic high.
- f. Return the scope to automatic triggering. Check at the buffer U44 pin 1 for a 1-kHz sine wave that steps repeatedly between 2 levels. The larger level should be 4 to 4.5 V pk-pk; the smaller, 1.2 to 1.3 V pk-pk.
- g. Check at the integrator U44 pin 8 or the equivalent test point S03 pin 1 for the waveform shown in Figure 5-9. Notice that the staircases each have .17 steps or 20 steps (for 1657.9700 and -9800, respectively) for 1 kHz but only 2 steps if you select 120 Hz (100 Hz).

ca. *Otherwise, check the associated amplifier U46 pin 6 for a similar waveform, 160 m V pk-pk. If this is not right, fault may be in U46/U42 circuit; if right, fault is in U43 circuitry.*

da. *If step d is not confirmed, or if the triggering fails, check SSW1 at pin 5. It should be a slow rectangular wave, (approx 3 Hz), switching between approx +5 V and -8 V. Otherwise, check U33 and U24; refer to para 5.8.5. If SSW1 is correct, U39 is faulty.*

ea. *Otherwise, or if the triggering fails, check SSW2 at pin 12. It should be a slow rectangular wave, (approx 3 Hz), from +5 V to -8 V. Otherwise, check U33 and U24; also refer to para 5.8.5. If SSW2 is correct, U39 is faulty.*

fa. *Otherwise, confirm that the input to this stage is*

correct bV checking at S03 pin 3 for sine wave that steps between 2 levels: 500 m V and 150 m V pk-pk. If this is correct, U44 is faulty.

Also, the amplitudes of the staircases depend on the RANGE selected and the impedance components of the DUT. The chosen conditions make 1 staircase taller than the other 7; so the waveform can be "stopped", by careful setting of scope sweep trigger adjustment. (Preferably, trigger on the positive slope, at a low voltage.)

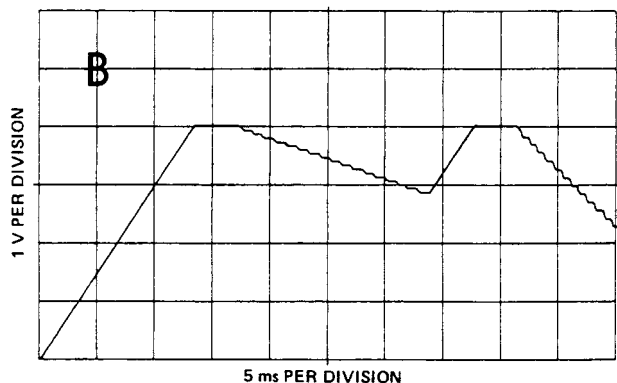
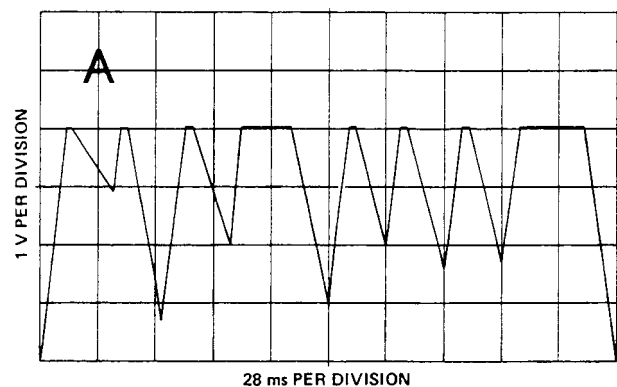

Figure 5-9. Integrator output waveform for the conditions of para 5.8.4. The full waveform is shown in A. It repeats at least 3 times per second, and includes 8 staircases, for a complete measurement cycle. The expansion, B, shows typical detail in the first 2 staircases. Each staircase has 17 steps for 1 kHz, 2 for 120 Hz in the 1657-9700 (20 for 1 kHz, 2 for 100 Hz in the 1657-9800).

h. Check at the comparator output U44 pin 14 or test point S03 pin 2 for CMP, a positive pulse (+5 V) on a base line about -5 V dc. Otherwise, U44 is faulty.

i. If a nonfunctional instrument passes all the preceding checks, i.e., no fault can be found in the analog circuitry, the fault is liable to be in digital circuitry.
See below.

5.8.5 Control Signal Checks.

Figures 5.10, 5-11.

If there is no staircase waveform at the integrator output (U44 pin 8), as described above, the following procedure is recommended to determine whether the fault is in the digital control circuitry.

ga. If step g is not verified, check at the switch control terminals U40 pins 5,6, 12, 13 for the presence of digital signals with logic high and low levels of +5 V and -8 V.

If all of these signals are present, either U40 or U44 is faulty; replace both of them. Otherwise, check U33 and U34. Also refer to para 5.8.5.

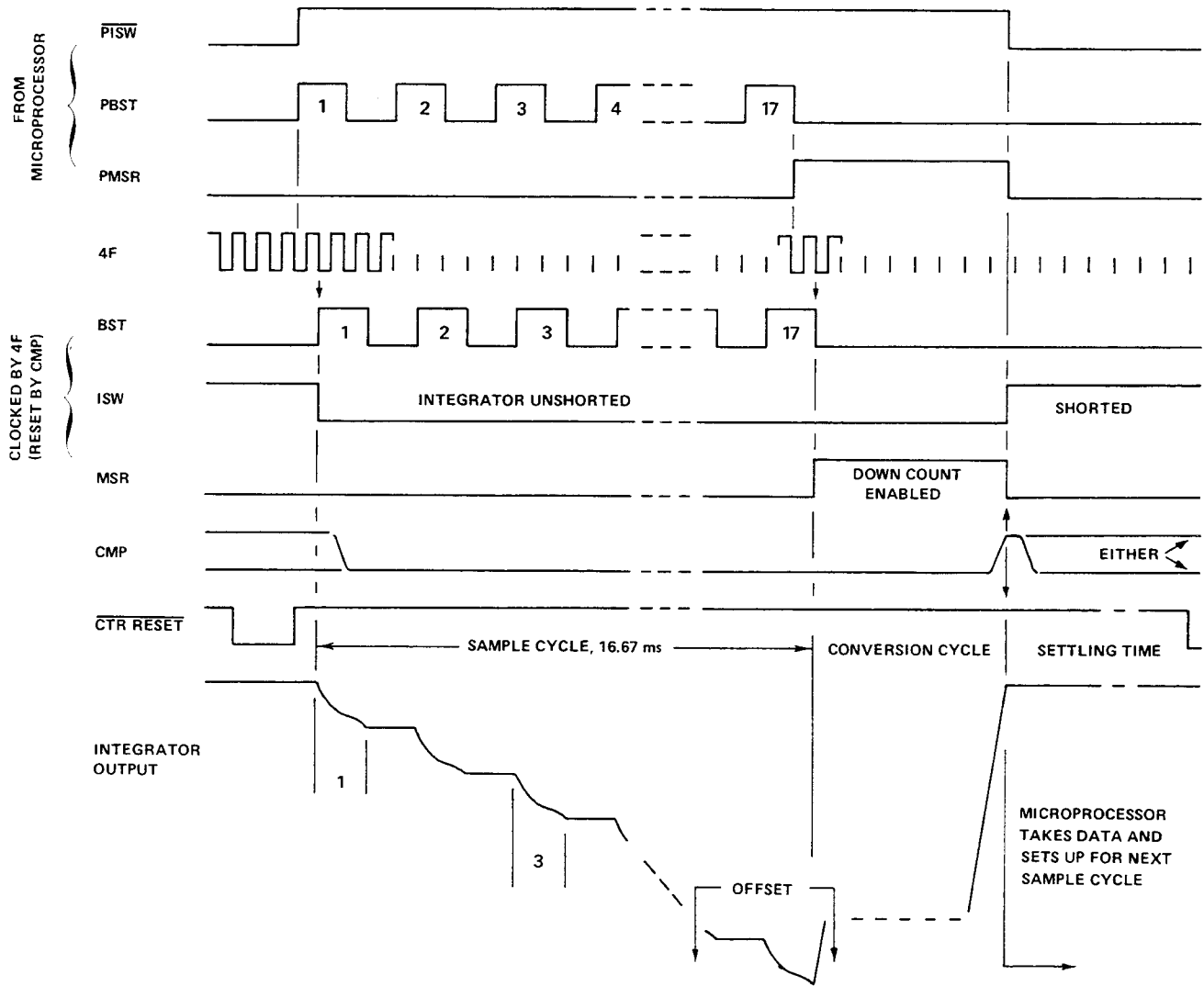

Figure 5-10. Timing diagram. One complete staircase cycle for a typical 1-kHz measurement on a 1657-9700. The 3 main divisions are: sample cycle (stair steps down), conversion cycle (smooth ramp up, during which a counter arrives at digital value of signal being sampled), and data-taking cycle (microprocessor takes data and sets up for next staircase). In this example, there are 17 samples taken.

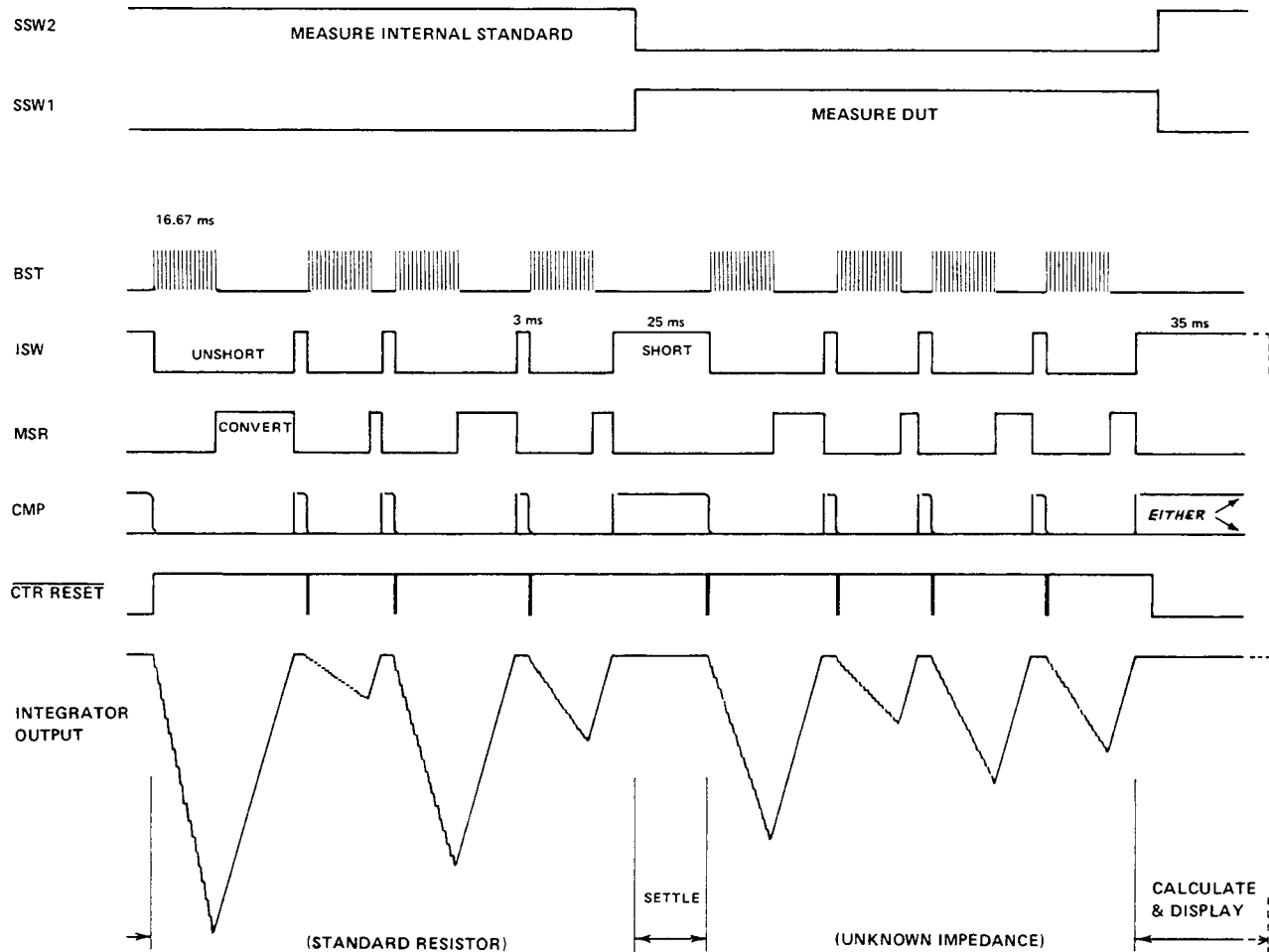

Figure 5-11. Timing diagram. One complete measurement cycle for a typical 1-kHz measurement on a 1657-9700. There are always 8 staircase cycles, one with each phase of BST for the signal from the standard (via U43 pin 8) and one with each phase of BST for the signal from the DUT (via U43 pin 1). The CMP pulses can take either a short or a long form (either is correct); the short ones are logic high for a fraction of a millisecond; the long ones are similar to ISW, but less sharp.

a. Look at the following control signals with a scope and compare them with the timing diagram:

- PBST, at C-U33 pin 10;
- PMSR, at U33 pin 12.

If they are normal, skip to step b. If they are inactive, perhaps they can be stimulated by applying pulses to the power-on reset circuit; see step aa.

b. Examine each of the following digital feedback

signals and compare it with the timing diagram. If anyone is questionable, check the circuit from which it is, derived;

F, 2F, and 4F, at U4 pins 2, 4, and 6 (from U17); DMSR, at U4 pin 10 (from PMSR via U33 and U34); DONE, at U25 pin 1 (from RES via U29 and U35).

Notice that DONE would echo CMP if the latter were provided as usual, by the integrator and comparator, U44. Otherwise, DONE echoes the reset pulse provided in step

'''

aa. Provide reset pulses in either of 2 ways. Preferably, set up a pulse generator as follows:

- Source resistance: 50 Ω .
- Repetition rate (period): 1 s.
- Pulse polarity and duration: positive, 0.5 s.
- DC levels: high = 4.5 V; low = 0 V.
- Connect from ground to: U6 pin 13.

ab. The alternative method is to short across C5 momentarily (and repeatedly) with a clip lead. Watch the scope carefully for activation, perhaps for only 1 cycle, of PBST and/or PMSR, after each application of the short circuit. Notice that this short must be only momentary and that it must not be applied while the pulse generator is connected. Find C5 at the rear edge of the C board, nearest Q1 which is between U6 and U7.

ac. If PBST and PMSR remain inactive in spite of the preceding stimulation, the digital control circuitry is at fault: go to para 5.8.6. Otherwise, proceed to step b, continuing to use the reset pulses.

c. If the feedback signals are present, look at each of the following control signals and compare it with the timing diagram: (The first 4 signals have logic low and high levels of 0 and +5 V; the last 8 signals, -8 and +5V)

- PBST, at U33 pin 10;
- PMSR, at U33 pin 12;
- PTSW, at U33 pin 8;
- RES, at U29 pin 8 (reset, normally only at power turn-on);
- SSW1, at U39 pin 5 (from PSSW1, at U33 pin 6);
- SSW2, at U39 pin 12 (from PSSW2, at U33 pin 2);
- Clock at U34 pin 9 (from 4F, at U29 pin 6);
- Reset at U34 pin 1 (from same sources as DONE);
- BST, at U40 pin 13 (clocked by 4F, enabled by PBST); BST, at U40 pin 5 (complement of BST);
- MSR at U40 pin 6 (clocked by 4F, enabled by PMSR); ISW, at U40 pin 12 (clocked by 4F, enabled by PISW).

If any is abnormal, trace back to the source of the signal, with the help of the schematic diagram (to check for poor connections or other interface problems). If the source is faulty, go to para 5.8.6. If these control signals are all valid, the fault is probably in the integrator U44 or associated circuits.

5.8.6 Digital Circuitry.

Display Board. A faulty integrated-circuit package can usually be identified by interchanging plug-in component parts of the same type between display channels. Notice that a resistor network need NOT be replaced as a unit; use ordinary resistors. (See para 5.8.1.)

Recommended Procedure. If careful analysis of a faulty instrument, using the preceding information, indicates that the trouble is in the digital circuitry (whether in control, computation, or display decoding), further analysis is beyond the scope of this manual. Return the faulty board (the C board, if the fault is digital, and not in the display board) or return the instrument for service. Refer to para 5.2 and 5.3.

Special Testing. Because of the very high speed and considerable complexity of the C-board digital circuitry, it is impossible to analyze trouble there with ordinary test equipment. GenRad production and in-factory service departments make use of fast, versatile automatic test systems (G R products). Their efficiency and accuracy are important factors in our recommendation that digital circuit problems be solved by exchanging boards.

Parts Lists and Diagrams- Section 6

6.1 GENERAL	6-1
6.2 REFERENCE DESIGNATIONS	6-1
6.3 DIAGRAMS.	6-1
Figure 6-1. Front view, mechanical parts	6-2
Figure 6-2. Rear view, mechanical parts	6-2
Federal Manufacturers Code	6-4
Figure 6-3. Analog and control (C) board, -4700, front end diagram.	6-5
Figure 6-4. Analog and control (C) board, 16574700, layout	6-6
Figure 6-5. Analog and control (C) board, -4700, signal sources diagram	6-7
Figure 6-6. Analog and control (C) board, -4700, digital control diagram	6-9
Figure 6-7. Display (D) board, 16684715, layout	6-10
Figure 6-8. Display (D) board, 1658-4715, diagram	6-11
Figure 6-9. Power supply (V) board, 1657-4720 layout	6-13
Figure 6-10. Power supply (V) assembly, 1657-4720, diagram	6-13

6.1 GENERAL.

This section contains the parts lists, circuit-board layout drawings and schematic diagrams for the instrument. (Section 4 contains functional block diagrams. Section 5 contains photographs of the instrument, identifying various parts.) The heavy lines on schematic diagrams denote the major signal flow.

Reference designation usage is described below.

6.2 REFERENCE DESIGNATIONS.

Each electrical component part on an assembly is identified on equipment and drawings by means of a reference designator comprised of numbers and letters. Component types on an assembly are numbered sequentially, the numbers being **preceded** by a letter designation that identifies the component (**R** for resistor, **C** for capacitor, etc.). Some of the less obvious designators are: DS, lamp; Q, transistor;

U, integrated circuit; WT, wire tie point; X, J, P, or SO, connector; Y, crystal resonator; Z, filter or network.

Each assembly (typically a circuit board) has its own sequence of designators which can be identified by using prefixes, such as A- for the main frame and V- for power supply. Examples: B-R8 designates B board, resistor 8; D-WT2 = D board, wire-tie point 2; CR6 on the V schematic is a shortened form of designator V-CR6 = V board, diode 6. The instrument may contain A-R 1, B-R 1, C-R 1, and D-RI.

6.3 DIAGRAMS.

Generally, each schematic diagram is located on a **right-hand** fold-out page for convenience. The associated layout drawing and parts list are located on the same page, the facing page, or otherwise nearby.

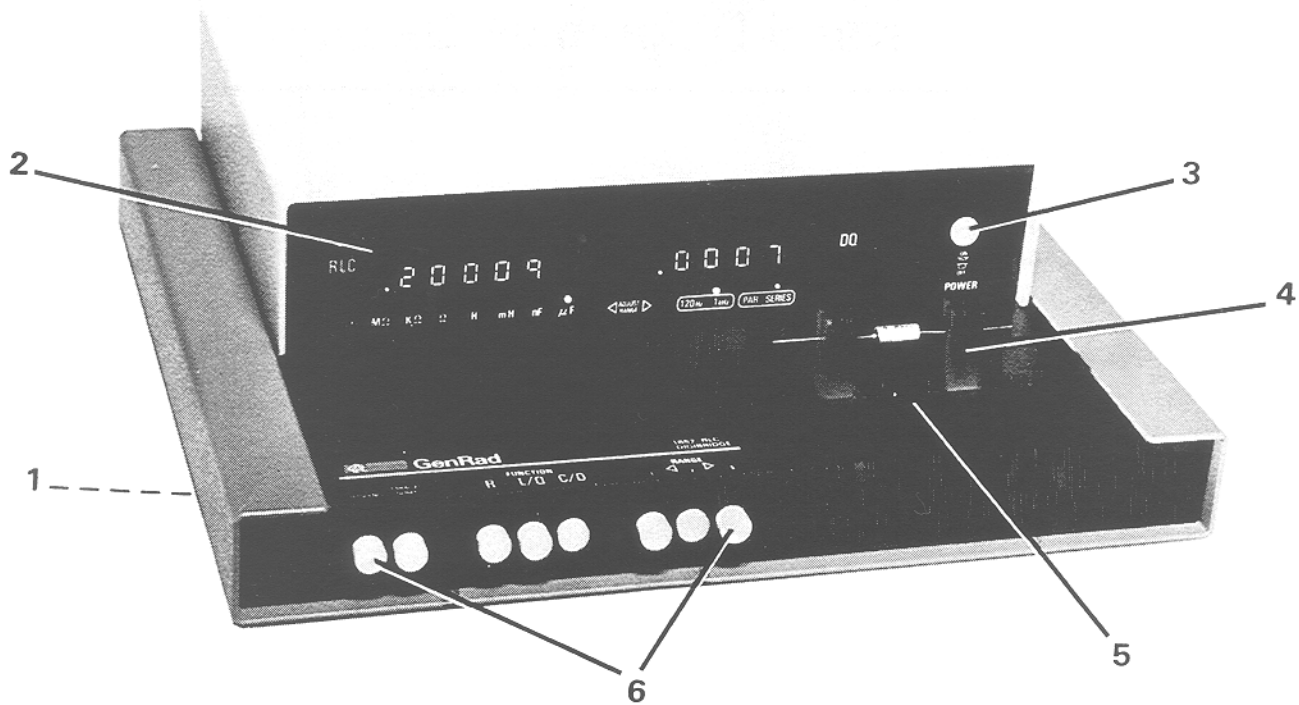

Figure 6-1. Front view showing mechanical replaceable parts.

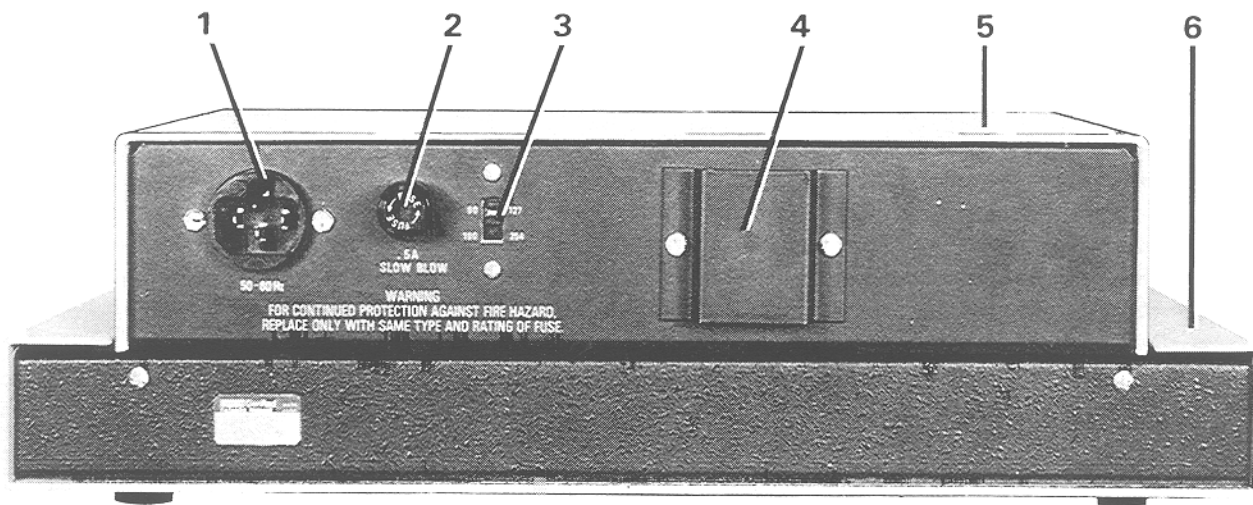

Figure 6-2. Rear view showing mechanical replaceable parts.

MECHANICAL PARTS LIST

FRONT (Figure 6-1)

Item	Description	Gen Rad Part	Mftr	Mftr Part No.
1	Foot (4 required) each:	5260-2051	24655	5260-2051
2	Display panel (120 Hz)	1657-7001	24655	1657-7001
	(or) Display panel (100 Hz)	1657-7002	24655	1657-7002
3	Switch actuator rod assembly	1657-2810	24655	1657-2810
4	Adaptor for axial leads (2 supplied)			
	Set of four for replacements	1657-5995	24655	1657-5995
5	Test fixture upper assembly, with rounded ends of slots	1657-2200	24655	1657-2200
	(includes dross tray	1657-7700	24655	1657-7700
	and foamed plasticpad)	1657-7800	24655	1657-7800
	Matching test fixture contacts (4 required; included on 1657-4700 board) each:	1686-1940	24655	1686-1940
5 (alt)	Test fixture upper assembly, with squared ends of slots	1689-2000	24655	1689-2000
	(includes dross tray and pad as above)			
	Matching test fixture contacts (4 required; included on 1657-4700 board) each:	1689-1015	24655	1689-1015
6	Push button cap (8 supplied)	5111-0450	71590	B-315 WT

REAR (Figure 6-2)

Item	Description	Gen Rad Part	Mftr	Mftr Part No.
1	Power connector J1	4240-0210	24655	4240-0210
2	Fuse extractor post F1	5650-0100	75915	342-004
3	Line voltage switch S2	7910-0832	82389	11A-1266
4	Cover	1657-8120	24655	1657-8120
5	Top cover	1657-8060	24655	1657-8060
6	Bottom shell	1657-8000	24655	1657-8000

FEDERAL SUPPLY CODE

FOR MANUFACTURERS

Ref FMC Column

From Defense Logistics Agency Microfiche

in Parts Lists

H4-2 SB 708-42 GSA-FSS H4-2

Code	Manufacturer	Code	Manufacturer	Code	Manufacturer	Code	Manufacturer
00136	McCoy Electrs., Mt. Holly Springs, PA 17065	15605	Couster Hammer, Milwaukee, WI 53202	66289	Sprague, North Adams, MA 0 247	80894	Pure Carbon, St. Marys, PA 15857
00192	Jones Mfg., Chicago, IL 60118	15782	Houston Inst., Bellair, TX 77401	66291	Simmons, Bayport, NY 11705	81030	Int'l Instr. Org., CT 06477
00194	Walco Electrs., Los Angeles, CA 90018	16801	Fenwal Electrc., Framingham, MA 01701	58553	Superior Valv., Washington, PA 15301	8 1073	Grayhill, LaGrange, IL 60626
00327	Weylyn Intntl., Westlake, OH 44145	15819	Sinclair & Rush, St. Louis, MO 63111	66730	Thomas & Betts, Elizabeth, NJ 07207	8 1433	Isolatone, Stirling, NJ 07880
00434	Schwaber Electrs., Westburg, NY 11590	16037	Spruce Pine Mica, Spruce Pine, NC 26777	69876	TRW, Cleveland, OH 44117	81312	Winchester, Oakville, CT 06779
00656	Aerovox, New Bedford, MA 02746	16068	Intntl. Diode, Jersey City, NJ 07304	60398	Torrington, Torrington, CT 06790	81349	Military Specifications
00779	AMP Inc., Harrisburg, PA 17105	16179	Omni Spectra, Farmington, MA 48024	61007	Townsend, Braitree, MA 02184	8 1360	Joint Army-Navy Specifications
01009	Alden Products, Brockton, MA 02413	16301	Astrolab, Linden, NJ 07036	6 6 37	Union Carbide, New York, NY 10017	81463	Int'l Rectifier, El Segundo, CA 90246
01121	Allen Bradley, Milwaukee, WI 53204	16352	Acti, Fairlawn, NJ 07410	6 6 64	United Carr Fast., Boston, MA	81741	Chicago Lock, Chicago, IL 60641
01261	Litton Inds., Beverly Hills, CA 90213	18495	Sterling Int'l., New Hyde Park, NY 11040	63060	Victoreen, Cleveland, OH 44104	81851	Filtrom, Flushing, NY 11354
01296	TRW, Lawrenceville, GA 30026	16636	Indiana General, Oglesby, IL 6 346	83743	Ward Leonard, Mt. Vernon, NY 10550	81840	Ledes., Dayton, OH 45402
01526	GE, Waynesboro, VA 22980	16758	Dalco, Kokomo, IN 46901	65063	Westinghouse, Bloomfield, NJ 07003	8 2 60	Barry Wright, Watertown, MA 02172
01930	Amerock, Rockford, IL 61101	16850	Precision Dynamics, Burbank, CA 91504	66042	Weston, Newark, NJ 07114	82219	Sylvania, Emporium, PA 15834
01963	Cherry Elect., Waukegan, IL 60085	16952	Amer Micro Devices, Summerville, SC 29483	70106	Acushnet Cap., New Bedford, MA 02742	82227	No. Amer. Philips, Cheshire, CT 06410
02111	Spectrol Electrs., City of Industry, CA 91745	17117	Elect. Molding, Woonsocket, RI 02895	70109	Adams & Westlake, Elkhart, IN 46514	82273	IN Pattern & Model, LaPort, IN 46350
02114	Ferrocube, Saugerties, NY 12477	17540	Mohawk Springs, Schiller Park, IL 60176	70417	Chrysler, Detroit, MI 4623	82369	Switchcraft, Chicago, IL 60630
02606	Fenwall Lab., Morton Grove, IL 60053	17745	Angstrom Precn., Hagerstown, MD 2 740	70663	Athletic India Rubber, Chicago, IL 60607	82687	Reeves Hoffman, Carlisle, PA 17013
02639	GE, Schenectady, NY 12307	17777	Singer, Somerville, NJ 06676	70661	Amperite, Union City, NJ 0 087	82647	Metals & Controls, Altoona, MA 02703
02660	Amphenol, Broadview, IL 60163	17850	Zetex, Concord, CA 64620	70611	Ark-Les Switch, Watertown, MA 02172	82807	Milwaukee Resistor, Milwaukee, WI 53204
02735	RCA, Somerville, NJ 08716	17859	Siliconix, Santa Clara, CA 95054	70892	Bead Chain, Bridgeport, CT 06605	82877	Rotron, Woodstock, NY 12498
02765	Fastex, Desplains, IL 60018	18324	Signetics, Sunnyvale, CA 94086	70933	Belden, Chicago, IL 60644	82901	IN General Magnet, Milwaukee, WI 46383
03042	Carter Ink., Cambridge, MA 02142	18342	Adia, Kokomo, IN 46902	71256	Roson, Beason, Falls, CT 05403	83003	Varo, Garland, TX 75040
03508	GE, Syracuse, NY 13201	18577	Scanbe, El Monte, CA 91731	7 1279	Cambridge Thermionic, Cambridge, MA 02138	83014	Hartwell, Placenta, CA 92670
03550	Vanguard Electrs., Inglewood, CA 90302	18736	Computer Diode, S. Fairlawn, NJ 07936	71294	Canfield, Clifton Forge, VA 24422	83033	Meissner, Mt. Carmel, IL 62626
03636	Gayburne, Yonkers, NY 10701	18795	Cycon, Sunnyvale, CA 95085	71400	Bussmann, St. Louis, MO 63107	83058	Carr Fastener, Cambridge, MA 02142
03877	Transitor Electrs., Wakefield, MA 01880	1891	Durant., Watertown, WI 53094	71450	CTS, Elkhart, IN 46514	83186	Victory Eng., Springfield, NJ 07081
03888	KDI Pyrofilm, Whippany, NJ 07981	19178	Geo., Monson, MA 0 057	71468	Cannon, Los Angeles, CA 90031	83266	Parker Seal, Culver City, CA 90231
03911	Clairex, New York, NY 10001	19209	Zer., Gainesville, FL 32601	7 4 82	Clare, Chicago, IL 64646	83360	H. H. Smith, Brooklyn, NY 11207
04009	Arrow Hart, Hartford, CT 06106	18373	Eastron, Haverhill, MA 0 830	71690	Centralab, Milwaukee, WI 53212	83361	Bearing Spicy, San Francisco, CA
04843	Diptronics, Alberton, NY 11507	19396	Paktron, Vienna, VA 22180	7 6 85	Continental Carbon, New York, NY	83667	Solar Electric, Warren, PA 15385
04713	Motorola, Phoenix, AZ 85008	19811	Catron, Chicago, IL 60622	71707	Conto Co., Providence, RI 02905	83594	Burruss, Philadelphia, PA 19395
04919	Component Mfg., W. Bridgewater, MA 02379	19644	LGC Electrs., Morehead, NY 14845	71729	Crane Co., Philadelphia, PA 19134	83766	Men Engrs., Quincy, MA 02171
05079	Transitor Electrs., Bennington, VT 05201	18701	Elect. Inds., Murray Hill, NJ 07974	71744	Chicago Min. Lamp, Chicago, IL 60640	83781	National Electrs., Geneva, IL 60134
05245	Cocorom, Chicago, IL 60639	20093	KMC, Long Valley, NJ 07863	71786	Cinch, Chicago, IL 60624	84111	TRW, Ogatsia, NB 69153
05276	ITT Electrs., Pomona, CA 9 786	20754	Fafnir Bearing, New Britain, CT 06050	71786	Daneel, Downey, CA 90241	84836	Lehigh Metals, Cambridge, MA 02140
05402	Controls Co. of Amer., Melrose Pk., IL 60160	21338	Raytheon, Norwood, MA 02062	72228	Electromotive, Willimantic, CT 06226	84970	Sarkes Tarzan, Bloomington, IN 47041
05574	Viking Inds., Chatsworth, CA 91311	2 7 66	Lenox Fusile, Watchung, NJ 07080	72266	Electromotive, New Bedford, MA 02742	84971	Ta Mfg., Los Angeles, CA 90039
06624	Barber Colman, Rockford, IL 6 101	22526	Berg Electrs., New Cumberland, PA 17070	72699	Nytronics, Berkeley, CA 94702	85604	Kepco, Flushing, NY 11352
05840	Barnes Mfg., Mansfield, OH 44801	22589	Elect. Space Fabrcrs., Topton, PA 19562	72766	Daiglight, Brooklyn, NY 11237	86420	Payson Casters, Gurnee, IL 60033
05728	Wakfield Eng., Wakefield, MA 0 880	22753	TD Electrs., Hollywood, FL 33022	72786	Drake, Inc., Newark, NJ 07104	85577	Pre-Herial Prod., Vahamam, MA 02180
06393	Panduit, Tinley Pk., IL 60477	23338	Wawetek, San Diego, CA 92121	72794	Dzus Fastener, W. Islip, NY 11795	85584	RCA, Harrison, NJ 07029
06406	Truelove & Maclean, Waterbury, CT 06708	23421	New Progr., Franklin Park, IL 60131	72942	Elastic Stop Nut, Union, NJ 07083	85687	REC, New Rochelle, NY 080
06665	Precision Monolith, Santa Clara, CA 95050	23936	Pamotor, Bellingham, CA 94010	72962	Erie, Erie, PA 16512	86800	Cont Electrs., Brooklyn, NY 11222
06743	Clevite, Cleveland, OH 44110	24361	Indiana Gnr Electrc., Keesby, NJ 08632	72682	Amperec Electrc., Hicksville, NY 11801	88140	Cutler Hammer, Lincoln, IL 62656
06795	WLS Stamp, Cleveland, OH 44104	24355	Analog Devices, Cambridge, MA 02142	73445	Carling Electrc., Hartford, CT 06110	88204	GTE Sylvania, Ipswich, MA 01938
06915	Relcho Pstc., Chicago, IL 60646	24444	General Semicond., Tempe, AZ 85281	73559	Eico Resistor, New York, NY	88219	Gould Nat. Battery, Trenton, NJ 08607
06928	Teledyne Kntcs., Soland Boh, CA 92075	24446	GE, Schenectady, NY 12305	73690	JFD Electrs., Brooklyn, NY 11219	88419	Cornell Dubilier, Fuquay Varina, NC 27526
06978	Aladdin Electrs., Nashville, TN 37210	24464	GE, Syracuse, NY 13201	73899	JFD Electrs., Brooklyn, NY 11219	86627	Potter & Brumfield, Princeton, IN 4767
07047	Ross Milton, Southampton, PA 18966	24455	EMC Techniq., Cherry Hill, NJ 08034	73667	Broov-Pin, Ridgefield, NJ 07857	86626	Holzer Control, Boston, MA 02119
07126	Digitron, Pasadena, CA 91105	24802	Gen. Con., Concord, MA 01741	74193	Heremant, Trenton, NJ 08610	86655	United Transformer, Chicago, IL
07237	Edge Signal, Baraboo, WI 53913	24555	Lenox Fusile, S. Plainfield, NJ 07080	74199	Quam Nichols, Chicago, IL 60637	86670	Berkshire Transformer, Kent, CT 06757
07123	Cinch Graphik, City of Industry, CA 91744	24759	Vacrite, Berkeley, CA 94710	74445	Holo-Krome, Hartford, CT 06110	90201	Mallory Cap., Indianapolis, IN 46206
07261	Averch, Culver City, CA 90230	25008	Hubbell, Stratford, CT 06497	74545	Industrial Cndr., Chicago, IL 60618	90303	Mallory Bat., Tarrytown, NY 10591
07263	Fairchild, Mountain View, CA 94040	25829	Amphenol, Danbury, CT 06810	74861	Johnson, Waseca, MN 55393	90634	Gulton Inds., Metuchen, NJ 08840
07387	Birther, N. Los Angeles, CA 90032	26801	Tri-Country Tube, Nunda, NY 14151	74902	IRCI (TRW), Burlington, IA 5260	90750	Westinghouse, Boston, MA 02118
07595	Amer. Semicond., Arlington Hts., IL 60004	26805	Omni Spectra, Waltham, MA 02154	75074	Kurz-Kasch, Dayton, OH 45401	90852	Hardware Prod., Reading, PA 19602
07699	Magnetic Core., Newburgh, NY 12550	26806	American Zetler, Costa Mesa, CA 62626	75372	Kuka, Mt. Vernon, NY 1066	91146	Continental Wire, York, PA 17405
07707	USM Fastener, Shelton, CT 06484	27014	National, Santa Clara, CA 95051	75376	Kuka, Mt. Vernon, NY 1066	91210	Cannon, Salem, MA 01970
07828	Bodine, Bridgeport, CT 06605	27455	Hartford Universal Bal., Rocky Hill, CT 06067	75626	Lafayette, Syracuse, NY 13291	91210	Gerber, Milwaukee, WI 46544
07829	Bodine, Elm., Phoenix, IL 40618	28480	HP, Palo Alto, CA 94304	75637	Heremant, Trenton, NJ 08610	91417	Harris, Melbourne, FL 32901
07983	State Labs., New York, NY 10003	28485	Heffman Mfg., Kenilworth, NJ 07033	75608	Quam Nichols, Chicago, IL 60637	91506	Augat Bros., Altoona, MA 02703
07999	Borg Int., Delavan, WI 53115	28959	C. C. Magnetics, Rochester, NY 03867	75915	Littelfuse, Des Plaines, IL 60016	91598	Chandler, Waterbury, CT 06709
08524	Deutch Fastener, Los Angeles, CA 90045	30043	Solid State Devices, LaMirada, CA 90638	76005	Lord Mfg., Erie, PA 16512	91637	Dale Electrs., Columbus, NE 68601
08556	Bell Electrc., Chicago, IL 60632	30646	Beckman Inst., Cedar Grove, NJ 07009	76149	Mallory Electrc., Detroit, MI 48204	91637	General Int., Dallas, TX 76220
08730	Vermaline Prod., Franklin Lakes, NJ 07417	30874	IBM, Armonk, NY 10504	76236	Maurey, Chicago, IL 60616	91619	Kings Electrs., Tuckahee, NY 11223
089213	GE, Buffalo, NY 14220	30886	Parmag Magnetics, Toledo, OH 43609	76264	3 M Co., St. Paul, MN 55101	91836	Mephisto Tool, Hudson, NY 12534
09353	C & K Components., Watertown, MA 02172	31019	Stand State Sontc., Montgomery, PA 18936	76385	Minor Rubber, Bloomfield, NJ 07003	91916	Muller Electrc., Cleveland, OH 44114
09408	Star-Tronics, Georgetown, MA 01830	31514	Stanford Appld Eng., Costa Mesa, CA 92626	76487	Millen, Malden, MA 02148	91923	Western Rubber, Goshen, IN 46526
09823	Burgess Battery., Freeport, IL 6 032	31814	Analogic, Wakefield, MA 0 880	76545	Muller Electrc., Cleveland, OH 44114	92519	Wiredmill, Hartford, CT 06110
09892	Fenwal Electrs., Framingham, MA 01701	31951	Trilog, Pittsburgh, PA 6 23	76684	Oak Int., Crystal Lake, IL 60014	92702	Edgerton Greenhouses, Boston, MA 02115
10025	Glassco Prod., Linden, NJ 07036	32001	Jensen, Chicago, IL 60641	76864	Dot Fastener, Waterbury, CT 06720	92709	IMC Magnetics, Westbury, NY 1 591
10389	Chicago Switch, Chicago, IL 60647	33173	GE, Owensboro, KY 42301	77147	Patton MacGuer, Providence, RI 02905	92866	Ampex., Redwood City, CA 94063
1 236	CTS of Berne, Berne, IN 46711	34141	Koehler, Marlboro, MA 0 7 6 2	77166	Pas Seymour, Syracuse, NY 13209	93332	Hudson Lab., Kearny, NJ 07032
11599	Chandler Evans, W. Hartford, CT 06101	34156	Semico, Costa Mesa, CA 62626	77263	Perry Roberts Rubber, Trenton, NJ 08638	93332	Sylvania, Woburn, MA 01801
11983	Nortronics, Minneapolis, MN 55427	34333	Silicon Genrl., Westminster, CA 92683	77316	Platt Bros., Waterbury, CT 06720	93634	Amer Electrs Labs., Landsale, PA 19446
12040	National, Santa Clara, CA 95051	34336	Advanced Micro Devices, Sunnyvale, CA 94086	77336	Positive Lockwasher, Newark, NJ 0667	93618	R&C Mfg., Ramsey, PA 6 67
12045	Electr Transistors, Flushing, NY 1 354	34649	Intel., Santa Clara, CA 95051	77342	AMF, Princeton, IN 47570	93916	Cramer, New York, NY 10013
12498	Teledyne, Mountain View, CA 94043	34677	Soltron Devices, Jupiter, FL 33468	77542	Ray-Vac, Madison, WI 63703	94144	Raytheon, Quincy, MA 02719
12617	Harnin, Lake Mills, WI 5366	35923	Constans, Montreal, QUE CAN	77630	TRW, Camden, NJ 08103	94154	Wagor, Elm., Livingston, NJ 07039
12871	RCA, Woodbridge, NJ 07095	36462	National, Ltd., Montreal, QUE CAN	77638	General Inst., Brooklyn, NY 11211	94271	Weston, Archibald, PA 07005
12897	Claroat., Dover, NH 03820	37942	National, Indianapolis, IN 46206	78189	Shakeproof, Elgin, IL 60120	94322	Tel Labs., Manchester, NH 03102
12856	Micrometals., City of Industry, CA 91744	38443	Marlin Rockwell, Jamestown, NY 470	78277	Sigma Inst., Braitree, MA 02184	94589	Dickson, Chicago, IL 60619
12954	Dickson Electrs., Scottsdale, AZ 85252	39317	McGill Mfg., Valparaiso, IN 46383	78426	Aircro Speer, St. Marys, PA 15867	94686	Magnecraft, Chicago, IL 60630
12969	Unirode, Watertown, MA 02172	40931	Honeywell, Minneapolis, MN 55408	78486	Stackpole, St. Marys, PA 15857	94800	Atlas Ind., Brookline, NH 03033
13034	Electrocraft, Hopkins, MN 66343	42190	Muter, Chicago, IL 60628	78553	Timmerman, Cleveland, OH	95076	Garde, Cumberland, RI 02864
13103	Thermalloy, Dallas, TX 75234	42498	National, Melrose, MA 02176	78711	Telephonics., Huntington, NY 11743	95121	Quality Comp., St. Marys, PA 15857
13148	Vogue Inst., Richmond Hill, NY 11418	43334	New Departure-Hyatt, Sandusky, OH 44870	79089	RCA, Harrison, NJ 07029	95146	Alco Electrs., Lawrence, MA 0 843
13150	Vernitron, Laconia, NH 03246	43931	Norma Hoffman, Stamford, CT 06904	79136	Waldes Kohnoor, New York, NY 11101	95236	Continental Conn., Woodstock, NY 11377
13271	Fairchild, San Rafael, CA 4 803	46171	RCA, New York, NY 10020	79477	Western Rubber, Goshen, IN 46526	95236	Vitramon, Bridgeport, CT 06601
13715	Burr Brown, Tucson, AZ 85706	48956	Raytheon, Waltham, MA 02154	79726	Wiredmill, Hartford, CT 06110	96346	Gordos, Bloomfield, NJ 07003
13819	Andax Int., Van Nuys, CA 9 406	50088	Mstek, Carrollton, TX 75006	79727	Continental Wirt., Philadelphia, PA 19101	96354	Method., Rolling Meadows, IL 00000
14010	Electr Controls, Wilton, CT 06897	50101	GHZ Devices, S. Chelmsford, MA 0 824	79840	Mallory Controls, Frankfort, IN 46041	95784	Amer Brass, Torrington, CT 06790
14196	American Labs., Fullerton, CA 92634	50507	Micro Networks, Worcester, MA 0 606	79963	Zierick, Mt. Kisco, NY 10649	95987	

CAUTION
 THE FOLLOWING COMPONENTS
 REQUIRE SPECIAL HANDLING
 FOR STATIC PROTECTION
 REFER TO CSMA-SHO-PTU-4-110
 U1, U2, U3, U4, U5, U6, U7, U8, U9,
 U10, U11, U12, U13, U14, U15,
 U16, U17, U18, U19, U20

NOTE: RANGE SWITCHES S1, S2, S3 INTERLOCK,
 SHOWN IN RANGE-1 POSITION.

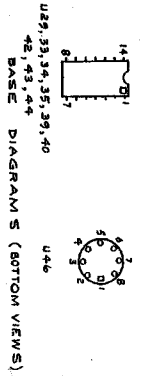

BASE DIAGRAM 5 (BOTTOM VIEWS)

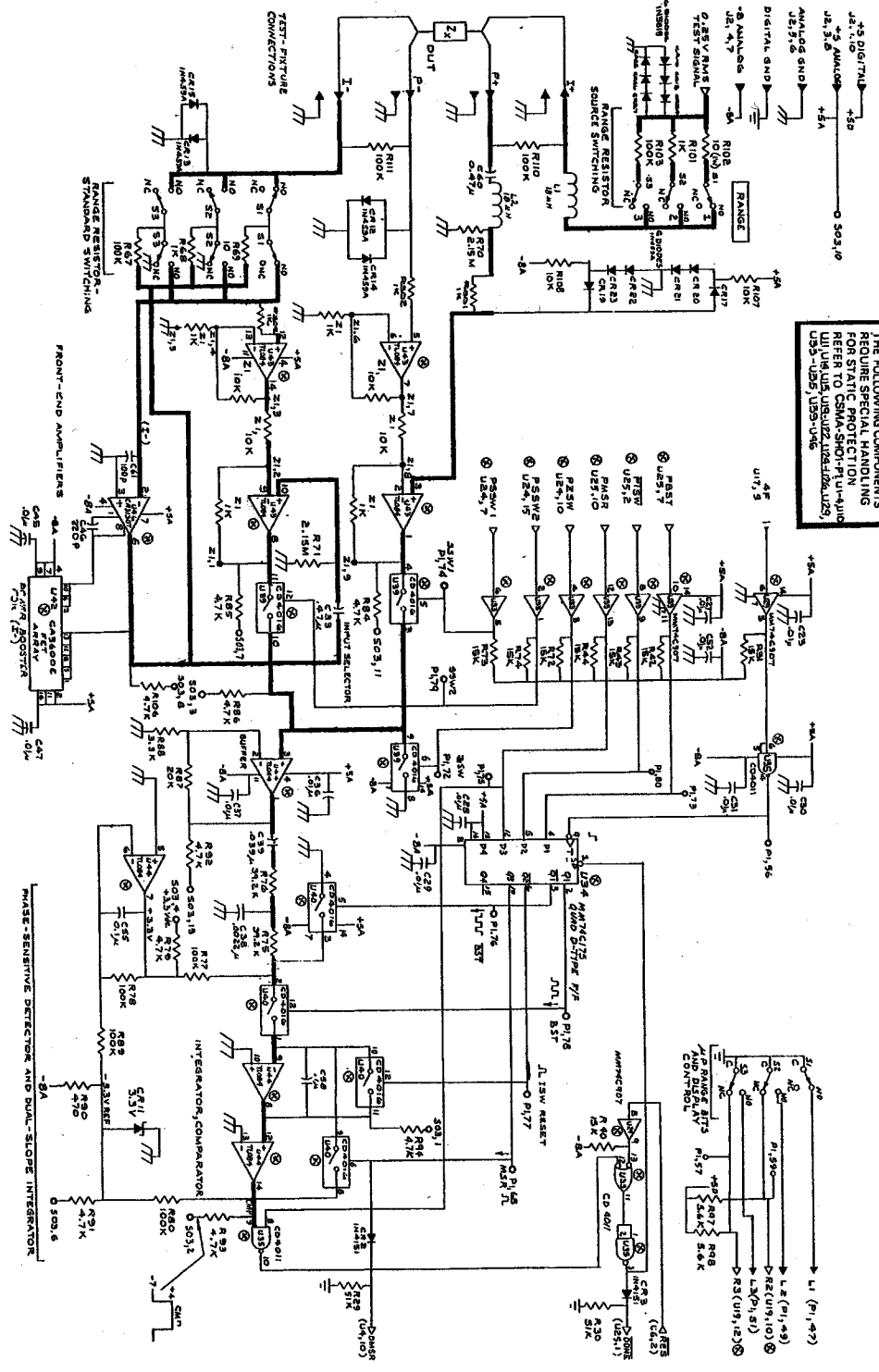
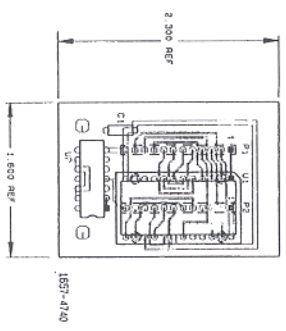
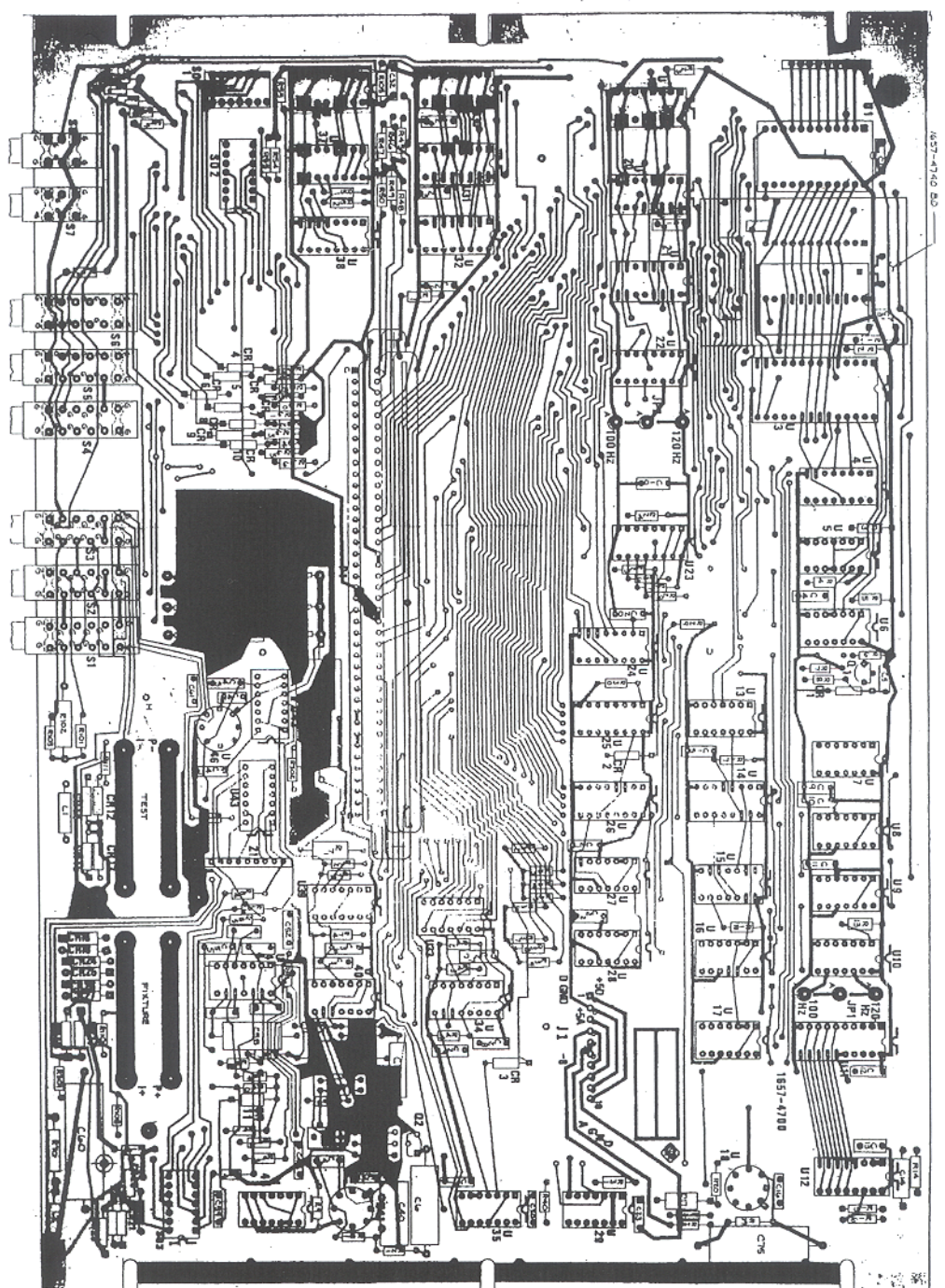

Figure 6-2. Analog and control (C) board, -4700, front and diagram.
 PARTS & DIAGRAMS 6-5

CAUTION: Protect static-sensitive components from damage in servicing. Refer to the static-protection procedures contained in the Service section of this manual, and the parts descriptions of the parts list.



1657-4740



1657-4740 50

Figure 64. Analog and control IC board, 1657-4700, layout.
6-6 PARTS & DIAGRAMS

CAUTION
 THE FOLLOWING COMPONENTS ARE NOT TO BE REWORKED FOR STATIC PROTECTION. REFER TO CSMA-SHOI-PI D137/100 ULL AND ULL/UC2 U22-10a U22E U22-10b FOR DETAILS.

RANGE 1	MS	LS	LS
RANGE 2	0	0	0
RANGE 3	0	0	0
RANGE 4	1	1	1

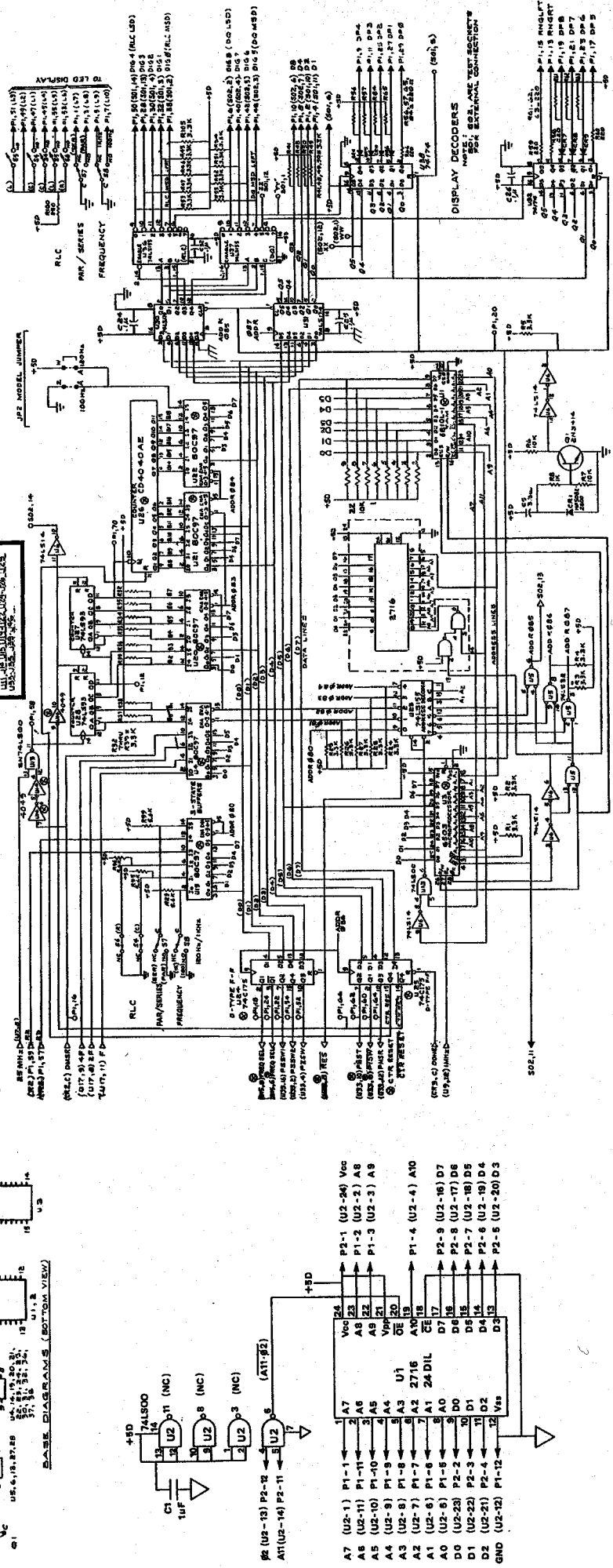
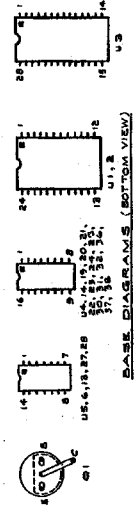

Figure 6-4. Analog and control (C) board, -4700, digital control diagram. PARTS & DIAGRAMS 6-4

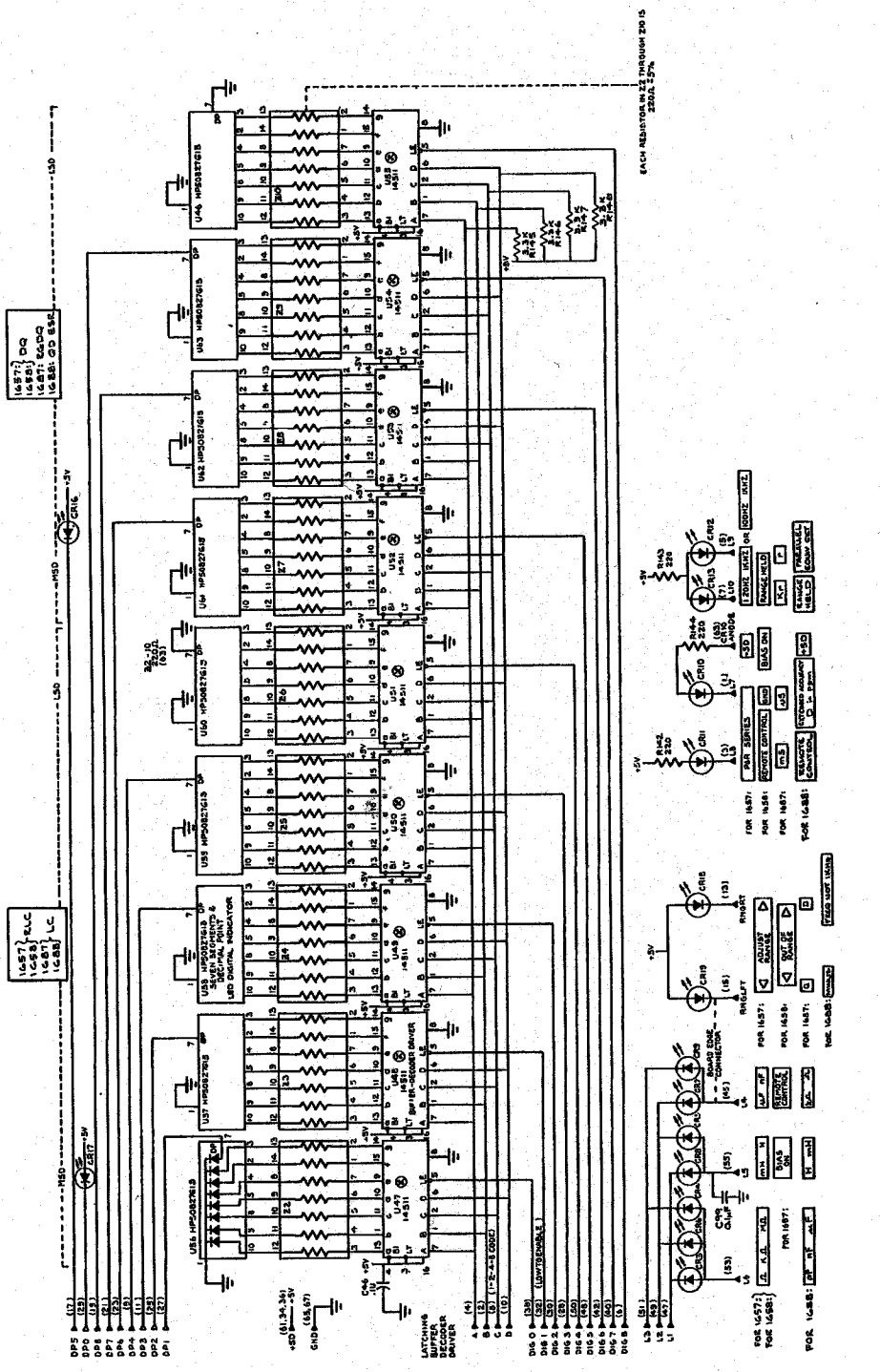

Figure 6-8. Display (D) board, 1658-0715, diagram. PARTS & DIAGRAMS 6-11

ELECTRICAL PARTS LIST

ELECTRICAL PARTS LIST

POWER SUPPLY ASH V		POWER SUPPLY PC BOARD	
REPDES	DESCRIPTION	PART NO.	P/MC
C	1 CAP ALUM 18000 UF 20V	4450-4231	24655
C	2 CAP ALUM 4800 UF 40V	4450-4221	92201
C	3 CAP TANT 1.0 UF 20PCT 35V	4450-4300	52289
C	6 CAP TANT 1.0 UF 20PCT 35V	4450-4300	52289
CR	1 DIODE BRIDGE	6081-1032	24655
CR	2 DIODE BRIDGE	6081-1032	24655
CR	3 DIODE BRIDGE	6081-1032	24655
CR	4 DIODE BRIDGE	6081-1032	24655
F	1 FUSE SLO-BLOW 1/2A 250V	5330-1000	75915
J	101 PECEPTACLE POWER UL 570 19A250V	4240-0250	82389
S	2 SWITCH SLIDE 2 POS DPDT STEADY S	7810-0832	82389
T	1 TRANSFORMER POWER	0485-4085	24655
U	1 IC LINEAR LM323	5432-1048	12040

REPDES	DESCRIPTION	PART NO.	P/MC
C	3 CAP TANT 1.0 UF 20PCT 35V	4450-4300	52289
C	4 CAP TANT 1.0 UF 20PCT 35V	4450-4300	52289
C	5 CAP CER 1000 .01 UF 10PCT 50V	4400-4351	75982
C	6 CAP CER 1000 .01 UF 10PCT 50V	4400-4351	75982
C	9 CAP CER 1000 .01 UF 10PCT 50V	4400-4351	75982
C	10 CAP CER 1000 .01 UF 10PCT 50V	4400-4351	75982
C	11 CAP TANT 1.0 UF 20PCT 35V	4450-4300	52289
CA	5 DIODE RECTIFIER 1N4003	6081-1001	14433
CA	6 DIODE RECTIFIER 1N4003	6081-1001	14433
CA	7 DIODE RECTIFIER 1N4003	6081-1001	14433
CA	8 DIODE RECTIFIER 1N4003	6081-1001	14433
CR	10 DIODE RECT 1N4140 100PIV 3A SI ALUM	6081-1014	14433
CR	10 RECT 1N4140 100PIV 3A SI ALUM	6081-1014	14433
S	1 SWITCH PUSH AC UL 6A	7870-1570	24655
U	2 IC LINEAR LM323P-5	5432-1058	12040
U	3 IC LINEAR LM323MP-8	5432-1059	12040

NOTE: THIS ASSEMBLY INCLUDES THE CIRCUIT BOARD

NOTE: Orientation: Viewed from parts side. Part number: Refer to caption.
 Symbolism: Outlined area = part; gray dot pattern = parts side, black (if any) = other side. Pin: Square pad in dot pattern = collector, (-C pin 1, cathode (for diode), or + end (for capacitor).

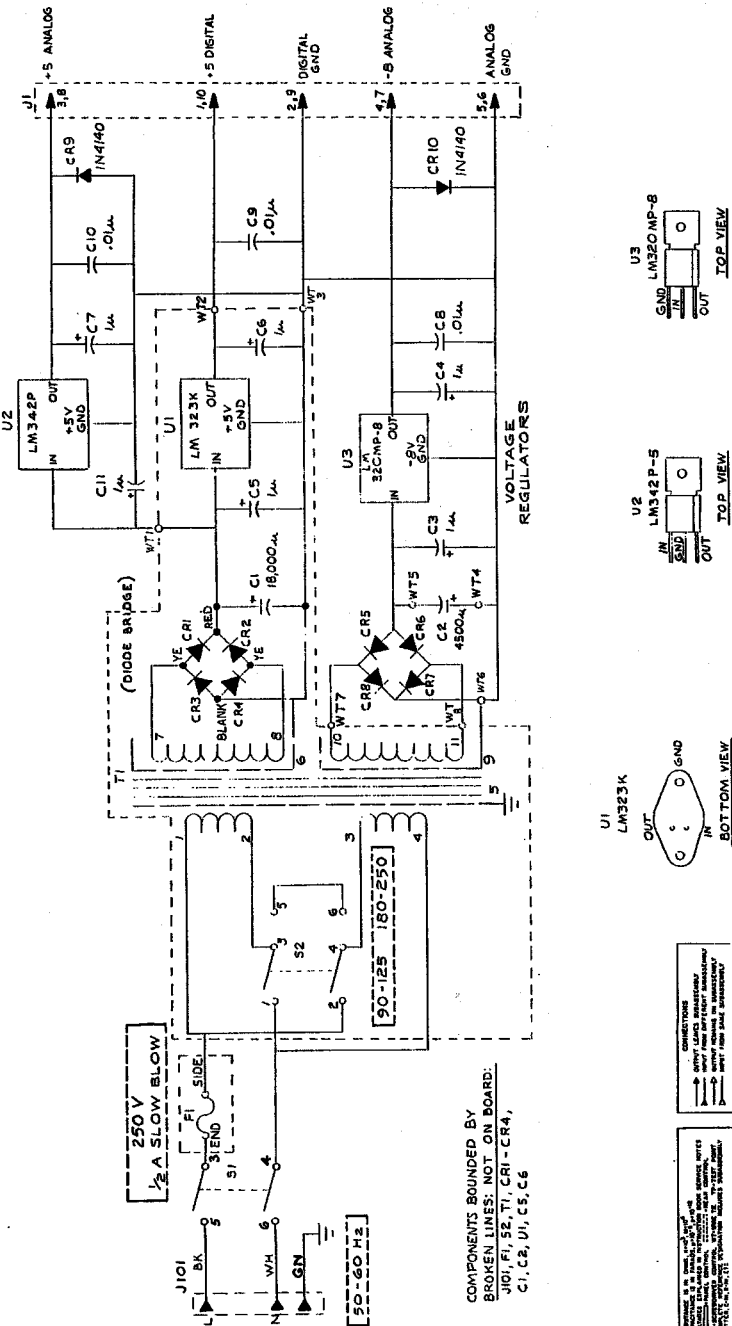
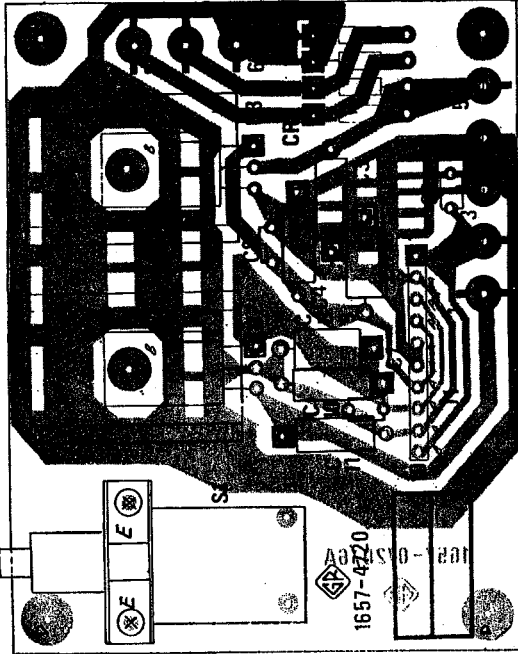

Figure 6-10. Power supply (VI) assembly, 1657-4220, diagram.